

FLUKE®

Calibration

5080A

Calibrator

Operators Manual

LIMITED WARRANTY AND LIMITATION OF LIABILITY

Each Fluke product is warranted to be free from defects in material and workmanship under normal use and service. The warranty period is one year and begins on the date of shipment. Parts, product repairs, and services are warranted for 90 days. This warranty extends only to the original buyer or end-user customer of a Fluke authorized reseller, and does not apply to fuses, disposable batteries, or to any product which, in Fluke's opinion, has been misused, altered, neglected, contaminated, or damaged by accident or abnormal conditions of operation or handling. Fluke warrants that software will operate substantially in accordance with its functional specifications for 90 days and that it has been properly recorded on non-defective media. Fluke does not warrant that software will be error free or operate without interruption.

Fluke authorized resellers shall extend this warranty on new and unused products to end-user customers only but have no authority to extend a greater or different warranty on behalf of Fluke. Warranty support is available only if product is purchased through a Fluke authorized sales outlet or Buyer has paid the applicable international price. Fluke reserves the right to invoice Buyer for importation costs of repair/replacement parts when product purchased in one country is submitted for repair in another country.

Fluke's warranty obligation is limited, at Fluke's option, to refund of the purchase price, free of charge repair, or replacement of a defective product which is returned to a Fluke authorized service center within the warranty period.

To obtain warranty service, contact your nearest Fluke authorized service center to obtain return authorization information, then send the product to that service center, with a description of the difficulty, postage and insurance prepaid (FOB Destination). Fluke assumes no risk for damage in transit. Following warranty repair, the product will be returned to Buyer, transportation prepaid (FOB Destination). If Fluke determines that failure was caused by neglect, misuse, contamination, alteration, accident, or abnormal condition of operation or handling, including overvoltage failures caused by use outside the product's specified rating, or normal wear and tear of mechanical components, Fluke will provide an estimate of repair costs and obtain authorization before commencing the work. Following repair, the product will be returned to the Buyer transportation prepaid and the Buyer will be billed for the repair and return transportation charges (FOB Shipping Point).

THIS WARRANTY IS BUYER'S SOLE AND EXCLUSIVE REMEDY AND IS IN LIEU OF ALL OTHER WARRANTIES, EXPRESS OR IMPLIED, INCLUDING BUT NOT LIMITED TO ANY IMPLIED WARRANTY OF MERCHANTABILITY OR FITNESS FOR A PARTICULAR PURPOSE. FLUKE SHALL NOT BE LIABLE FOR ANY SPECIAL, INDIRECT, INCIDENTAL, OR CONSEQUENTIAL DAMAGES OR LOSSES, INCLUDING LOSS OF DATA, ARISING FROM ANY CAUSE OR THEORY.

Since some countries or states do not allow limitation of the term of an implied warranty, or exclusion or limitation of incidental or consequential damages, the limitations and exclusions of this warranty may not apply to every buyer. If any provision of this Warranty is held invalid or unenforceable by a court or other decision-maker of competent jurisdiction, such holding will not affect the validity or enforceability of any other provision.

Fluke Corporation
P.O. Box 9090
Everett, WA 98206-9090
U.S.A.

Fluke Europe B.V.
P.O. Box 1186
5602 BD Eindhoven
The Netherlands

OPERATOR SAFETY SUMMARY

WARNING

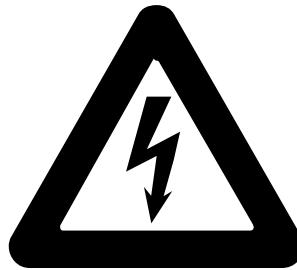

HIGH VOLTAGE

is used in the operation of this equipment

LETHAL VOLTAGE

may be present on the terminals, observe all safety precautions!

To avoid electrical shock hazard, the operator should not electrically contact the output HI or sense HI terminals or circuits connected to these terminals. During operation, lethal voltages of up to 1020 V ac or dc may be present on these terminals.

Whenever the nature of the operation permits, keep one hand away from equipment to reduce the hazard of current flowing through vital organs of the body.

Table of Contents

Chapter	Title	Page
1	Introduction and Specifications.....	1-1
	Introduction.....	1-3
	Safety Information	1-3
	Operation Overview.....	1-5
	Where to Go from Here	1-5
	Instruction Manuals	1-6
	5080A Operators Manual	1-6
	5080A Getting Started Manual.....	1-6
	How to Contact Fluke.....	1-6
	General Specifications	1-7
	Detailed Specifications	1-8
	DC Voltage.....	1-8
	DC Current	1-8
	Resistance.....	1-9
	AC Voltage (Sine Wave).....	1-10
	AC Current (Sine Wave)	1-11
	DC Power Summary.....	1-12
	AC Power Summary.....	1-12
	Power and Dual Output Limits.....	1-12
	Phase.....	1-13
	Calculating Power Specifications.....	1-13
	Frequency	1-14
2	Operation Preparation	2-1
	Introduction.....	2-3
	Unpacking and Inspection.....	2-3
	Replacing the Fuse.....	2-3
	Selecting Line Voltage.....	2-4
	Connecting to Line Power	2-4
	Selecting Line Frequency	2-4
	Service Information	2-6
	Cooling Considerations.....	2-7
	Accessories and Options	2-8
	Rack Mount Considerations.....	2-8

3	Features	3-1
	Introduction.....	3-3
	Front-Panel Features	3-3
	Rear-Panel Features	3-3
	Softkey Menu Trees.....	3-3
4	Front-Panel Operations.....	4-1
	Introduction.....	4-3
	Turning on the Calibrator.....	4-3
	Warming up the Calibrator	4-4
	Using the Softkeys.....	4-4
	Using the Setup Menu.....	4-4
	Using the Instrument Setup Menu	4-5
	Utility Functions Menu.....	4-5
	Using the Format NV Memory Menu	4-6
	Resetting the Calibrator	4-6
	Zeroing the Calibrator.....	4-6
	Using the Operate and Standby Modes.....	4-7
	Connecting the Calibrator to a UUT	4-8
	Recommended Cable and Connector Types.....	4-8
	When to Use EARTH	4-9
	Four-Wire versus Two-Wire Connections	4-9
	Cable Connection Instructions.....	4-10
	Auto Range Versus Locked Range.....	4-12
	Setting the Output	4-13
	Setting DC Voltage Output	4-13
	Setting AC Voltage Output	4-14
	Setting DC Current Output.....	4-16
	Setting AC Current Output.....	4-17
	Setting DC Power Output.....	4-18
	Setting AC Power Output.....	4-20
	Setting a Dual DC Voltage Output.....	4-22
	Setting a Dual AC Voltage Output.....	4-24
	Setting Resistance Output.....	4-27
	Sine Wave Output.....	4-28
	Adjusting the Phase	4-29
	Entering a Phase Angle	4-30
	Entering a Power Factor	4-31
	Editing and Error Output Settings.....	4-31
	Editing the Output Setting	4-32
	Displaying the UUT Error: AC and DC Voltage and Current Output.....	4-32
	Displaying the UUT Error: Resistance Output.....	4-33
	Using Multiply and Divide.....	4-33
	Setting Voltage and Current Limits	4-33
5	Remote Operations	5-1
	Introduction.....	5-3
	Setting up the RS-232 Host Port for Remote Control.....	5-4
	Configuring the Ethernet (LAN) Port	5-5
	Setting the IP Address	5-6
	Selecting Dynamic Host Configuration Protocol (DHCP).....	5-6
	Setting a Static Internet Address.....	5-7
	Setting the LAN Subnet Mask.....	5-7
	Reading the Domain Name	5-7

Configuring the Host Name.....	5-7
Reading the MAC Address.....	5-8
Configuring the LAN Default Gateway	5-8
Configuring the General Network Socket Port.....	5-8
Establishing an Ethernet Connection.....	5-9
Terminating an Ethernet Connection.....	5-9
Changing Between Remote and Local Operation.....	5-10
Local State.....	5-10
Local and Lockout State.....	5-10
Remote State.....	5-10
Remote with Lockout State.....	5-10
RS-232 Interface Overview	5-11
Using Commands.....	5-11
Types of Commands.....	5-11
Device-Dependent Commands.....	5-11
Common Commands.....	5-12
Query Commands.....	5-12
Compound Commands.....	5-12
Coupled Commands.....	5-12
Overlapped Commands.....	5-12
Sequential Commands.....	5-13
Commands that Require the Calibration Switch.....	5-13
Command Syntax	5-13
Parameter Syntax Rules	5-13
Extra Space or Tab Characters.....	5-15
Terminators	5-15
Incoming Character Processing.....	5-15
Response Message Syntax	5-15
Checking 5080A Status	5-17
Serial Poll Status Byte (STB).....	5-17
Master Summary Status	5-19
Service Request Enable Register (SRE).....	5-19
Programming the STB and SRE.....	5-19
Event Status Register (ESR)	5-19
Event Status Enable (ESE) Register.....	5-19
Bit Assignments for the ESR and ESE.....	5-20
Programming the ESR and ESE.....	5-20
Instrument Status Register (ISR).....	5-20
Instrument Status Change Registers.....	5-20
Instrument Status Change Enable Registers.....	5-21
Bit Assignments for the ISR, ISCR, and ISCE	5-21
Programming the ISR, ISCR, and ISCE	5-22
Output Queue.....	5-22
Error Queue	5-22
Input Buffer Operation	5-22
6 Remote Commands.....	6-1
Introduction.....	6-3
Command Summary by Function	6-3
Command Details	6-7
7 Maintenance.....	7-1
Introduction.....	7-3
How to Replace the Line Fuse.....	7-3

How to Replace the Current Fuses.....	7-5
How to Clean the Air Filter	7-7
General Cleaning	7-8
Performance Tests.....	7-9

Appendices

A Glossary.....	A-1
B RS-232 Cabling and Connector.....	B-1
C Error Messages.....	C-1

List of Tables

Table	Title	Page
1-1.	Symbols.....	1-4
2-1.	Standard Equipment.....	2-3
2-2.	Line Power Cord Types Available from Fluke.....	2-6
2-3.	Accessories and Options.....	2-8
3-1.	Front-Panel Features.....	3-4
3-2.	Rear-Panel Features.....	3-9
3-3.	Factory Defaults for SETUP Menus Power-Up Defaults.....	3-20
4-1.	UUT connections.....	4-10
4-2.	Standard Calibrator Resistances.....	4-27
4-3.	Keys That Exit Error Mode.....	4-32
5-1.	Operating State Transitions.....	5-11
5-2.	Units Accepted in Parameters and Used in Responses.....	5-14
5-3.	Terminator Characters.....	5-15
5-4.	Response Data Types.....	5-16
5-5.	Status Register Summary.....	5-17
6-1.	Common Command Summary.....	6-3
6-2.	Error Mode Command Summary.....	6-4
6-3.	External Connection Command Summary.....	6-4
6-4.	Output Command Summary.....	6-4
6-5.	RS-232 Host Port Command Summary.....	6-5
6-6.	Setup and Utility Command Summary.....	6-6
6-7.	Status Command Summary.....	6-7
6-8.	Overlapped and Coupled Commands.....	6-8
6-9.	Default Setup Values.....	6-13
7-1.	Replacement Fuses.....	7-3
7-2.	Current Fuses.....	7-6
7-3.	Verification Tests for DC Voltage (Normal).....	7-9
7-4.	Verification Tests for DC Voltage (AUX).....	7-10
7-5.	Verification Tests for DC Current.....	7-10
7-6.	Verification Tests for 2-Wire Resistance.....	7-11
7-7.	Verification Tests for 4-Wire Resistance.....	7-11
7-8.	Verification Tests for AC Voltage (Normal).....	7-12
7-9.	Verification Tests for AC Current.....	7-13
7-10.	Verification Tests for Phase.....	7-14
7-11.	Verification Tests for Distortion.....	7-15

7-12. Verification Tests for Frequency..... 7-15

List of Figures

Figure	Title	Page
2-1.	Fuse Access and Line Voltage Selection	2-5
2-2.	Line Power Cord Types Available from Fluke	2-6
3-1.	Front-Panel View	3-4
3-2.	Rear-Panel View	3-9
3-3.	SETUP Softkey Menu Tree.....	3-11
4-1.	UUT Connection: Resistance (4-Wire Compensation).....	4-10
4-2.	UUT Connection: Resistance (2-Wire Compensation).....	4-11
4-3.	UUT Connection: Resistance (Compensation Off).....	4-11
4-4.	UUT Connection: DC Voltage/AC Voltage.....	4-12
4-5.	UUT Connection: DC Current/AC Current	4-12
4-6.	Sine Wave	4-29
5-1.	Typical RS-232 Remote Control Connections.....	5-3
5-2.	Menus to Set LAN Parameters.....	5-6
5-3.	Status Register Overview	5-18
5-4.	Serial Poll Status Byte (STB) and Service Request Enable (SRE)	5-19
5-5.	Event Status Register (ESR) and Event Status Enable (ESE).....	5-20
5-6.	Bit Assignments for the ISR, ISCEs, and ISCRs	5-21
7-1.	Accessing the Fuse	7-4
7-2.	Current Fuse Compartment	7-6
7-3.	Accessing the Air Filter.....	7-8

Chapter 1

Introduction and Specifications

Title	Page
Introduction.....	1-3
Safety Information	1-3
Operation Overview.....	1-5
Where to Go from Here	1-5
Instruction Manuals	1-6
5080A Operators Manual	1-6
5080A Getting Started Manual.....	1-6
How to Contact Fluke	1-6
General Specifications	1-7
Detailed Specifications	1-8
DC Voltage.....	1-8
DC Current	1-8
Resistance.....	1-9
AC Voltage (Sine Wave).....	1-10
AC Current (Sine Wave)	1-11
DC Power Summary	1-12
AC Power Summary	1-12
Power and Dual Output Limits.....	1-12
Phase.....	1-13
Calculating Power Specifications.....	1-13
Frequency	1-14

Introduction



Warning

If the 5080A Calibrator is operated in any way not specified by this manual or other documentation provided by Fluke, the protection provided by the Calibrator may be impaired.

The 5080A Calibrator is a fully programmable precision source of the following:

- DC voltage from 0 V to ± 1020 V.
- AC voltage from 1 mV to 1020 V, with output from 45 Hz to 1 kHz.
- AC current from 29 μ A to 20.5 A, with variable frequency limits.
- DC current from 0 to ± 20.5 A.
- Discrete resistance values from a short circuit to 190 M Ω .

Features of the 5080A Calibrator include the following:

- Automatic meter error calculation.
-  and  keys that change the output value to pre-determined cardinal values for various functions.
- Programmable entry limits that prevent entering invalid amounts.
- Simultaneous output of voltage and current, up to an equivalent of 20.9 kVA.
- Simultaneous output of two voltages.
- Variable phase signal output.
- EIA Standard RS-232 serial data interface for printing, displaying, or transferring internally stored calibration constants, and for remote control of the 5080A.

Safety Information





This Calibrator complies with:

- ANSI/ISA-61010-1 (82.02.01)
- CAN/CSA C22.2 No. 61010-1-04
- ANSI/UL 61010-1:2004
- EN 61010-1:2001

In this manual, a **Warning** identifies conditions and actions that pose a hazard to the user. A **Caution** identifies conditions and actions that may damage the Calibrator or the equipment under test.

Symbols used on the Calibrator and in this manual are explained in Table 1-1.

Table 1-1. Symbols

Symbol	Description	Symbol	Description
~	AC (Alternating Current)		Earth Ground
	Important Information: refer to manual		Shock Hazard
CE	Complies with EU directives		Complies with relevant North American Safety Standards.
CAT I	IEC Measurement Category I – CAT I is for measurements not directly connected to mains. Maximum transient Overvoltage is as specified by terminal markings.		Do not dispose of this product as unsorted municipal waste. Go to Fluke's website for recycling information.

This manual contains information, warnings, and cautions that must be followed to ensure safe operation and to maintain the Calibrator in a safe condition.

Warning

To avoid possible electric shock or personal injury, follow these guidelines:

- Use this Calibrator only as specified in this manual or the protection provided by the Calibrator might be impaired.
- Do not apply more than 264 V ac rms between the supply conductors or between either supply conductor and ground.
- Use caution when working with voltages above 30 V ac rms, 42 V peak, or 60 V dc. These voltages pose a shock hazard.
- Ensure the Calibrator is in STANDBY by pressing the RESET key before disconnecting test leads.
- Ensure the grounding conductor in the power cord is properly connected to a protective ground. The output terminals are clamped to the earth referenced chassis and rely on the protective earth bond to limit accessible voltage to the operator. Any disruption of the protective earth could place lethal voltage onto the chassis of the Calibrator due to abnormal output terminal configuration or mains transient condition.
- Use only the replacement fuses specified by the manual.
- Do not position the Calibrator such that the power cord cannot be accessed in the event of an emergency. In the event that customer installation interferes with access to the power cord, a suitable power disconnection switch shall be provided by the customer.
- Use only the power cord and connector appropriate for the voltage and plug configuration in your country.

- **Use only a power cord that is in good condition. Refer power cord and connector changes to qualified service personnel.**
- **Do not operate the Calibrator in an atmosphere of explosive gases.**
- **Verify the voltage applied to the unit under test does not exceed the insulation rating of the UUT and the interconnecting cables.**
- **Do not remove the Calibrator cover without first disconnecting the power cord.**
- **Do not operate the Calibrator without the cover properly installed. Access procedures and the warnings for such procedures are contained in the Service Manual. Service procedures are for qualified service personnel only.**
- **Do not use the Calibrator if it appears damaged or operates abnormally. Refer all questions of proper Calibrator operation to qualified service personnel.**

⚠ Caution

To avoid damage to the Calibrator, do not apply voltage in excess of the marked rating to any terminal.

Operation Overview

The 5080A Calibrator may be operated at the front panel in the local mode, or remotely using RS-232 or Ethernet ports. For remote operations, several software options are available to integrate 5080A operation into a wide variety of calibration requirements.

Typical local operations include front panel connections to the Unit Under Test (UUT), and then manual keystroke entries at the front panel to place the Calibrator in the desired output mode. The front panel layout facilitates hand movements from left to right, and multiply and divide keys make it easy to step up or down at the press of a single key. You can also review 5080A Calibrator specifications at the push of two buttons. The backlit liquid crystal display is easy to read from many different viewing angles and in different lighting conditions, and the large, easy-to-read keys are color-coded and provide tactile feedback.

Where to Go from Here

To locate specific information concerning the installation and operation of the 5080A Calibrator, refer to the following list:

- Unpacking and setup: Chapter 2, “Preparing for Operation”
- AC line power and interface cabling: Chapter 2, “Preparing for Operation”
- Controls, indicators, and displays: Chapter 3, “Features”
- Front-panel operation: Chapter 4, “Front-Panel Operation”
- Cabling to a UUT (Unit Under Test): Chapter 4, “Front-Panel Operation”
- Remote operation (Ethernet or serial): Chapter 5, “Remote Operation”
- Performance Specifications: Chapter 1, “Introduction and Specifications”

Instruction Manuals

The 5080A Manual Set provides complete information for operators and service or maintenance technicians. The set includes:

- *5080A Operators Manual* (provided on CD-ROM)
- *5080A Getting Started Manual* (PN 3502934)
- *5080A Service Manual* (PN 3790039)

The Operators and Getting Started manuals listed above are shipped with the Calibrator. For ordering instructions, refer to the Fluke Catalog, or ask a Fluke sales representative (see “Service Information” in Chapter 2).

To view, print, or download the latest manual supplement, visit <http://us.fluke.com/usen/support/manuals>.

5080A Operators Manual

This 5080A Operators Manual provides complete information on installing the 5080A Calibrator and operating it from the front-panel keys and in remote configurations. This manual also provides a glossary of calibration, specifications, and error code information. The Operators Manual includes the following topics:

- Installation
- Operating controls and features, including front-panel operation
- Remote operation (Ethernet or serial port remote control)
- Serial port operation (printing, displaying, or transferring data, and setting up for serial port remote control)
- Operator maintenance, including verification procedures and calibration approach for the 5080A
- Accessories and Options

5080A Getting Started Manual

The *5080A Getting Started Manual* contains a brief introduction to the 5080A Manual Set, instructions on how to get your Calibrator prepared for operation and a complete set of specifications.

How to Contact Fluke

To order accessories, receive operating assistance, or get the location of the nearest Fluke distributor or Service Center, call:

- Technical Support USA: 1-800-99-FLUKE (1-800-993-5853)
- Calibration/Repair USA: 1-888-99-FLUKE (1-888-993-5853)
- Canada: 1-800-36-FLUKE (1-800-363-5853)
- Europe: +31-402-675-200
- China: +86-400-810-3435
- Japan: +81-3-3434-0181
- Singapore: +65-738-5655
- Anywhere in the world: +1-425-446-5500

Or, visit Fluke's website at www.fluke.com.

To register your product, visit <http://register.fluke.com>.

To view, print, or download the latest manual supplement, visit <http://us.fluke.com/usen/support/manuals>.

General Specifications

All specifications are valid after a warm-up period of 30 minutes, or twice the time since last warmed up, to a maximum of 30 minutes. For example, if the 5080A has been turned off for 5 minutes, the warm-up period is 10 minutes.

All specifications apply for the temperature and time period indicated. For temperatures outside of $t_{cal} \pm 5\text{ }^{\circ}\text{C}$ (t_{cal} is the ambient temperature when the 5080A was calibrated), the temperature coefficient as stated in the General Specifications must be applied.

The specifications also assume the 5080A is zeroed every seven days or whenever the ambient temperature changes by more than $5\text{ }^{\circ}\text{C}$.

Warmup Time	Twice the time since last warmed up, to a maximum of 30 minutes.
Settling Time	Less than 7 seconds for all functions and ranges except as noted.
Standard Interfaces.....	RS-232 and Ethernet
Temperature	
Operating	$0\text{ }^{\circ}\text{C}$ to $50\text{ }^{\circ}\text{C}$
Calibration (t_{cal}).....	$15\text{ }^{\circ}\text{C}$ to $35\text{ }^{\circ}\text{C}$
Storage	$-20\text{ }^{\circ}\text{C}$ to $+70\text{ }^{\circ}\text{C}$
Temperature Coefficient	Temperature coefficient for temperatures outside $t_{cal} \pm 5\text{ }^{\circ}\text{C}$ is 10 % of the stated specification per $^{\circ}\text{C}$ for temperatures in the range of $0\text{ }^{\circ}\text{C}$ to $35\text{ }^{\circ}\text{C}$. Above $35\text{ }^{\circ}\text{C}$, the temperature coefficient is 20 % of the stated specification per $^{\circ}\text{C}$.
Relative Humidity	
Operating	$<80\text{ }\%$ to $30\text{ }^{\circ}\text{C}$, $<70\text{ }\%$ to $40\text{ }^{\circ}\text{C}$, $<40\text{ }\%$ to $50\text{ }^{\circ}\text{C}$.
Storage	$<95\text{ }\%$, non-condensing
Altitude	
Operating	2,000 m (6,500 ft) maximum
Non-operating	12,200 m (40,000 ft) maximum
Safety	Meets EN 61010-1:2001, CAN/CSA-C22.2 No. 61010-1-04, UL 61010-1:2004 Insulation Class I (bonded enclosure) Pollution Degree 2 Indoor use only.
Analog Low Isolation.....	20 V
EMC	Meets EN 61326-1:2006.
Line Power	
Line Voltage (selectable)	100 V, 120 V, 220 V, 240 V
Line Frequency	47 to 63 Hz
Line Voltage Variation.....	$\pm 10\text{ }\%$ about line voltage setting
Power Consumption.....	600 VA
Dimensions	
Height.....	19.3 cm (7.6 in)
Width.....	43.2 cm (17 in), 44.3 cm (17.5 in) including handles
Depth	53.8 cm (21.2 in)
Weight.....	22 kg (48 lb)
Specification Definition.....	The specifications include stability, temperature coefficient, linearity, line and load regulation, and the traceability of the external standards used for calibration. It is not necessary to add anything to determine the total specification for the temperature range indicated.
Specification Confidence Level.....	99 %

Detailed Specifications

DC Voltage

Range	Specification, tcal ± 5 °C \pm (% of output + μ V)		Stability	Resolution (μ V)	Max Burden ^[1]
	90 days	1 year	24 hours, ± 1 °C \pm (% of output + μ V)		
0 to 329.999 mV	0.011 % + 10	0.013 % + 10	0.0035 % + 6	1	60 Ω
0 to 3.29999 V	0.008 % + 15	0.010 % + 15	0.0025 % + 10	10	300 mA
0 to 32.9999 V	0.008 % + 150	0.010 % + 150	0.0025 % + 100	100	600 mA
10 to 101.999 V	0.010 % + 1500	0.012 % + 1500	0.003 % + 1000	1000	300 mA
30 to 329.999 V	0.010 % + 1500	0.012 % + 1500	0.003 % + 1000	1000	120 mA
100 to 1020.00 V	0.010 % + 5500	0.012 % + 5500	0.003 % + 5000	10000	40 mA
Auxiliary Output (dual output mode only)					
0 to 329.99 mV	0.10 % + 1000	0.12 % + 1000	0.03 % + 300	10	5 mA
0.33 to 3.2999 V	0.10 % + 1000	0.12 % + 1000	0.03 % + 300	100	5 mA
3.3 to 7.000 V	0.10 % + 1000	0.12 % + 1000	0.03 % + 300	1000	5 mA

[1] Remote sensing is not provided. Output resistance is 60 Ω for outputs <330 mV. Output resistance is <5 m Ω for outputs \geq 0.33 V. The AUX output has an output resistance of <1 Ω .

Range	Noise	
	Bandwidth 0.1 Hz to 10 Hz, p-p \pm (ppm of output + floor)	Bandwidth 10 Hz to 10 kHz, rms \pm (floor)
0 to 329.999 mV	0 + 3 μ V	20 μ V
0 to 3.29999 V	0 + 30 μ V	200 μ V
0 to 32.9999 V	0 + 300 μ V	2 mV
10 to 101.999 V	30 + 5 mV	60 mV
30 to 329.999 V	30 + 5 mV	60 mV
100 to 1020.00 V	30 + 20 mV	100 mV
Auxiliary Output (dual output mode only)		
0 to 329.99 mV	0 + 20 μ V	60 μ V
0.33 to 3.2999 V	0 + 200 μ V	600 μ V
3.3 to 7.000 V	0 + 2 mV	3 mV

DC Current

Range	Specification, tcal ± 5 °C \pm (% of output + μ A)		Resolution	Max. Compliance Voltage (V)	Max. Inductive Load
	90 days	1 year			
0 to 329.99 μ A	0.07 % + 0.1	0.075 % + 0.1	10 nA	9	2.5 H
0 to 3.2999 mA	0.06 % + 0.25	0.065 % + 0.25	0.1 μ A	9	
0 to 32.999 mA	0.048 % + 1.25	0.05 % + 1.25	1 μ A	50	
0 to 329.99 mA	0.048 % + 16.5	0.05 % + 16.5	10 μ A	35	
0 to 1.0999 A (in 3 A range)	0.14 % + 220	0.15 % + 220	100 μ A	6	
1.1 to 2.9999 A	0.18 % + 220	0.19 % + 220	100 μ A	6	
0 to 10.999 A (in 20 A range)	0.23 % + 2500	0.25 % + 2500	1 mA	4	
11 to 20.500 A ^[1]	0.48 % + 3750	0.5 % + 3750	1 mA	4	

[1] Duty Cycle: Currents <11 A may be provided continuously. For currents >11 A, the current may be provided 60-T-I minutes in any 60 minute period where T is the temperature in °C (room temperature is about 23 °C) and I is the output current in Amps. For example, 17 A at 23 °C could be provided for 60-17-23 = 20 minutes each hour. When the 5080A is outputting currents between 5 and 11 amps for long periods, the internal self-heating reduces the duty cycle. Under those conditions, the allowable "on" time indicated by the formula is achieved only after the 5080A is outputting currents <5 A for the "off" period first.

Range	Noise	
	Bandwidth 0.1 Hz to 10 Hz, p-p	Bandwidth 10 Hz to 10 kHz, rms
0 to 329.99 μ A	20 nA	60 nA
0 to 3.2999 mA	200 nA	600 nA
0 to 32.999 mA	2 μ A	6 μ A
0 to 329.99 mA	20 μ A	60 μ A
0 to 2.9999 mA	200 μ A	3 mA
0 to 20.500 A	2 mA	30 mA

Resistance

Nominal Value	Specification of Characterized Value, tcal ± 5 °C, \pm (% of value or Ω) ^[1]		Max. Difference of Characterized Value to Nominal Value, \pm (%) ^[2]	2-Wire Adder, $\pm(\Omega)$ ^[3]	Full Spec. Load Range, I_{min} to I_{max} ^[4]	Max. Peak Current
	90 days	1 year				
0 Ω	0.01 Ω	0.01 Ω	-	0.001 Ω	8 to 210 mA	220 mA
1 Ω	0.99 %	1.0 %	1.75 %	0.001 Ω	8 to 210 mA	220 mA
1.9 Ω	0.49 %	0.5 %	0.85 %	0.001 Ω	8 to 210 mA	220 mA
10 Ω	0.14 %	0.15 %	0.23 %	0.001 Ω	5 to 90 mA	220 mA
19 Ω	0.09 %	0.1 %	0.18 %	0.001 Ω	4 to 65 mA	160 mA
100 Ω	0.035 %	0.04 %	0.05 %	0.001 Ω	2 to 15 mA	70 mA
190 Ω	0.035 %	0.04 %	0.05 %	0.001 Ω	1 to 11 mA	50 mA
1000 Ω	0.022 %	0.025 %	0.045 %	0.01 Ω	0.5 to 4.5 mA	22 mA
1.9 k Ω	0.022 %	0.025 %	0.045 %	0.01 Ω	0.2 to 3.3 mA	16 mA
10 k Ω	0.022 %	0.025 %	0.045 %	0.1 Ω	0.1 to 1.5 mA	3 mA
19 k Ω	0.026 %	0.029 %	0.045 %	0.2 Ω	0.05 to 1 mA	1.6 mA
100 k Ω	0.035 %	0.038 %	0.045 %	2 Ω	10 to 280 μ A	0.3 mA
190 k Ω	0.039 %	0.042 %	0.045 %	8 Ω	5 to 150 μ A	0.16 mA
1 M Ω	0.035 %	0.04 %	0.055 %	-	1 to 28 μ A	30 μ A
1.9 M Ω	0.035 %	0.04 %	0.055 %	-	0.5 to 15 μ A	16 μ A
10 M Ω	0.09 %	0.1 %	0.18 %	-	0.1 to 2.8 μ A	3 μ A
19 M Ω	0.14 %	0.15 %	0.23 %	-	0.05 to 1.5 μ A	1.6 μ A
100 M Ω	0.49 %	0.5 %	1.45 %	-	10 to 280 nA	300 nA
190 M Ω	0.99 %	1.0 %	1.5 %	-	5 to 150 nA	160 nA

[1] Specifications apply to the displayed value, using 4-wire connections up to 190 k Ω .
 [2] For 21 to 25 °C, <70 % RH.
 [3] For all except 4-wire (COMP 4 wire) mode, 2-wire internal (COMP off) and external (COMP 2-wire) compensation is available up to 190 k Ω .
 [4] For currents less than the specified load range, where I_{min} is the minimum load current in the table and I_{actual} is the actual load current: Specification = Table specification X (I_{min} / I_{actual}).

AC Voltage (Sine Wave)

Range	Frequency	Specification, tcal ± 5 °C \pm (% of output + μ V)		Resolution	Max. Burden ^[1]	Max. Distortion & Noise 10 Hz to 100 kHz Bandwidth ^[2] \pm (% of output + floor)
		90 days	1 year			
1.00 to 32.99 mV	45 to 65 Hz	0.31 % + 60	0.33 % + 60	10 μ V	60 Ω	0.1 % + 300 μ V
	65 Hz to 1 kHz	0.32 % + 60	0.34 % + 60			
33 to 329.99 mV ^[3]	45 to 65 Hz	0.13 % + 60	0.15 % + 60	10 μ V	60 Ω	0.1 % + 300 μ V
	65 Hz To 1 KHz	0.14 % + 60	0.16 % + 60			
0.33 to 3.2999 V ^[3]	45 to 65 Hz	0.09 % + 180	0.10 % + 180	100 μ V	300 mA	0.2 % + 600 μ V
	65 Hz to 1 kHz	0.10 % + 180	0.11 % + 180			
3.3 to 32.999 V	45 to 65 Hz	0.09 % + 1800	0.10 % + 1800	1 mV	800 mA	0.5 % + 6 mV
	65 Hz to 1 kHz	0.11 % + 1800	0.12 % + 1800			
33 to 101.99 V	45 to 65 Hz	0.12 % + 18000	0.14 % + 18000	10 mV	400 mA	0.5 % + 30 mV
	65 Hz to 1 kHz	0.13 % + 18000	0.15 % + 18000			
102 to 329.99 V	45 to 65 Hz	0.12 % + 18000	0.14 % + 18000	10 mV	120 mA	0.5 % + 30 mV
	65 Hz to 1 kHz	0.13 % + 18000	0.15 % + 18000			
330 to 1020.0 V	45 to 65 Hz	0.12 % + 180000	0.14 % + 180000	100 mV	40 mA	0.5 % + 100 mV
	65 Hz to 1 kHz	0.13 % + 180000	0.15 % + 180000			
Auxiliary Output (dual output mode only)						
10 to 329.99 mV	45 to 65 Hz	0.18 % + 1000	0.20 % + 1000	10 μ V	5 mA	0.2 % + 600 μ V
	65 Hz to 1 kHz	0.20 % + 1000	0.22 % + 1000			
0.33 to 3.2999 V	45 to 65 Hz	0.18 % + 1000	0.20 % + 1000	100 μ V	5 mA	0.2 % + 600 μ V
	65 Hz to 1 kHz	0.20 % + 1000	0.22 % + 1000			
3.3 to 5.000 V	45 to 65 Hz	0.18 % + 1000	0.20 % + 1000	1 mV	5 mA	0.2 % + 600 μ V
	65 Hz to 1 kHz	0.20 % + 1000	0.22 % + 1000			
<p>[1] Remote sensing is not provided. Output resistance is 60 Ω for outputs <330 mV. Output resistance is <5 mΩ for outputs \geq0.33 V. The AUX output resistance is <1 Ω. The maximum load capacitance is 500 pF.</p> <p>[2] For a resistive load. Bandwidth of 10 Hz to 10 kHz for Auxiliary Output.</p> <p>[3] In dual output mode with output currents >0.33 A, the floor specification is 3X for specified outputs.</p>						

AC Current (Sine Wave)

Range	Frequency	Specification, tcal $\pm 5^\circ\text{C} \pm(\%$ of output + μA)		Compliance Adder ^[2] ($\mu\text{A/V}$)	Max. Distortion & Noise 10 Hz to 10 kHz Bandwidth $\pm(\%$ of output + floor)	Max. Inductive Load (μH)
		90 days	1 year			
LCOMP OFF						
29.0 to 329.9 μA	45 to 65 Hz	0.24 % + 0.75	0.25 % + 0.75	0.05	0.2 % + 3 μA	200
	65 Hz to 1 kHz	0.25 % + 0.75	0.26 % + 0.75	0.15		
0.33 to 3.2999 mA	45 to 65 Hz	0.21 % + 0.9	0.22 % + 0.9	0.05	0.2 % + 5 μA	200
	65 Hz to 1 kHz	0.22 % + 0.9	0.23 % + 0.9	0.15		
3.3 to 32.999 mA	45 to 65 Hz	0.09 % + 12	0.10 % + 12	0.05	0.2 % + 15 μA	50
	65 Hz to 1 kHz	0.18 % + 12	0.19 % + 12	0.15		
33 to 329.99 mA	45 to 65 Hz	0.09 % + 120	0.10 % + 120	0.1	0.2 % + 150 μA	50
	65 Hz to 1 kHz	0.18 % + 120	0.19 % + 120	0.2		
0.33 to 1.0999 A	45 to 65 Hz	0.09 % + 1200	0.10 % + 1200	10	0.35 % + 1.5 mA	2.5
	65 Hz to 1 kHz	0.22 % + 1200	0.24 % + 1200	125		
1.1 to 2.9999 A	45 to 65 Hz	0.09 % + 1500	0.10 % + 1500	10	0.35 % + 1.5 mA	2.5
	65 Hz to 1 kHz	0.26 % + 1500	0.28 % + 1500	125		
3.0 to 10.999 A	45 to 65 Hz	0.24 % + 6000	0.25 % + 6000	10	0.6 % + 15 mA	1
	65 Hz to 1 kHz	0.38 % + 6000	0.40 % + 6000	125		
11 to 20.500 A ^[1]	45 to 65 Hz	0.48 % + 15000	0.50 % + 15000	10	0.6 % + 15 mA	1
	65 Hz to 1 kHz	0.50 % + 15000	0.52 % + 15000	125		
LCOMP ON						
29.0 to 329.9 μA	45 to 65 Hz	0.24 % + 0.75	0.25 % + 0.75	0.05	0.3 % + 3 μA	2.5 H ^[3]
0.33 to 3.2999 mA		0.21 % + 0.9	0.22 % + 0.9	0.05	0.5 % + 5 μA	
3.3 to 32.999 mA		0.19 % + 9	0.20 % + 9	0.05	0.5 % + 15 μA	
33 to 329.99 mA		0.19 % + 90	0.20 % + 90	0.1	0.5 % + 150 μA	
0.33 to 1.0999 A		0.20 % + 900	0.21 % + 900	10	0.6 % + 1.5 mA	
1.1 to 2.9999 A		0.22 % + 900	0.23 % + 900	10	0.6 % + 1.5 mA	
3.0 to 10.999 A		0.24 % + 6000	0.25 % + 6000	10	0.6 % + 1.5 mA	
11 to 20.500 A ^[1]		0.48 % + 15000	0.50 % + 15000	10	0.6 % + 1.5 mA	
<p>[1] Duty Cycle: Currents <11 A may be provided continuously. For currents >11 A, the current may be provided 60-T-1 minutes in any 60 minute period where T is the temperature in $^\circ\text{C}$ (room temperature is about 23°C) and I is the output current in amps. For example, 17 A at 23°C could be provided for 60-17-23 = 20 minutes each hour. When the 5080A is outputting currents between 5 and 11 amps for long periods, the internal self-heating reduces the duty cycle. Under those conditions, the allowable "on" time indicated by the formula is achieved only after the 5080A is outputting currents <5 A for the "off" period first.</p> <p>[2] To be applied for compliance voltages >1 V rms.</p> <p>[3] Subject to compliance voltage limits.</p>						

Range	Resolution (μA)	Max. Compliance Voltage, LCOMP Off, V rms	Max. Compliance Voltage, LCOMP On, V rms
29.0 to 329.9 μA	0.1	3.3 ^[1]	3.3 ^[1]
0.33 to 3.2999 mA	0.1	6.5	6.5
3.3 to 32.999 mA	1	6.5	44
33 to 329.99 mA	10	6	25
0.33 to 2.9999 A	100	4	4
3 to 20.500 A	1000	3	3
[1] Load impedance <10 k Ω .			

DC Power Summary

Time	Voltage	Currents			
		0.33 to 3.2999 mA	3.3 to 329.99 mA	0.33 to 2.9999 A	3 to 20.5 A
		Specification, tcal ± 5 °C, \pm (% of watts output) ^[1]			
90 days	33 mV to 1020 V	0.14	0.11	0.21	0.52
1 year	33 mV to 1020 V	0.15	0.11	0.22	0.54

[1] To determine the actual dc power specification, see the individual "DC Voltage Specifications", "DC Current Specifications", and "Calculating Power Specifications" sections. The actual specification at the operating point will usually be significantly better than the table value, since the specifications state the minimum performance for the voltages and currents listed.

AC Power Summary

Time	Voltages	Currents			
		3.3 to 8.9999 mA	9 to 32.999 mA	33 to 89.99 mA	90 to 329.99 mA
		Specification, tcal ± 5 °C, 45 to 65 Hz, PF = 1, \pm (% of watts output)			
90 days	33 to 329.999 mV	0.56	0.43	0.56	0.43
	330 mV to 1020 V	0.50	0.34	0.50	0.34
1 year	33 to 329.999 mV	0.58	0.45	0.58	0.45
	330 mV to 1020 V	0.51	0.36	0.51	0.36

		Currents			
		0.33 to 0.8999 A	0.9 to 2.1999 A	2.2 to 4.499 A	4.5 to 20.5 A
		Specification, tcal ± 5 °C, 45 to 65 Hz, PF = 1, \pm (% of watts output)			
90 days	33 to 329.999 mV	0.57	0.43	0.54	0.69
	330 mV to 1020 V	0.51	0.35	0.47	0.64
1 year	33 to 329.999 mV	0.59	0.46	0.56	0.72
	330 mV to 1020 V	0.52	0.37	0.49	0.67

Notes
To determine the actual ac power specification, see the individual "AC Voltage Specifications", "AC Current Specifications", "Phase Specifications", and "Calculating Power Specifications" sections. The actual specification at the operating point will usually be significantly better than the table value, since the specifications state the minimum performance for the voltages and currents listed.

Power and Dual Output Limits

Frequency	Voltages (NORMAL)	Currents	Voltages (AUX)	Power Factor (PF)
DC	0 to ± 1020 V	0 to ± 20.5 A	0 to ± 7 V	-
45 to 65 Hz	33 mV to 1000 V	3.3 mA to 20.5 A	100 mV to 5 V	0 to 1
	330 mV to 1000 V	33 mA to 2.9999 A	100 mV to 5 V	0 to 1
65 to 500 Hz	3.3 V to 1000 V	33 mA to 20.5 A	100 mV to 5 V	0 to 1
	330 mV to 1000 V	33 mA to 20.5 A	100 mV to 5 V	1

Notes
The range of voltages and currents shown in "DC Voltage Specifications", "DC Current Specifications", "AC Voltage Specifications", and "AC Current Specifications" are available in the power and dual output modes, except that the minimum current for AC power is 0.33 mA. However, only the voltages and currents shown in this table are specified. See "Calculating Power Specifications" to determine the specification at any points within this table.
The phase adjustment range for dual AC outputs is 0 ° to ± 179.9 °. The phase resolution for dual AC outputs is 0.1 degree.
Power and dual output amplitude settling times are typically <9 seconds.

Phase

Specification, 1 year, tcal ±5 °C, ±(ΔΦ) ^{[1][2]}		
45 TO 65 Hz	65 to 500 Hz	500 Hz to 1 kHz
0.25 °	1.5 °	5.0 °
[1] See Power and Dual Output Limit specifications for applicable outputs. [2] Phase settling times are typically <18 seconds additional.		

Phase (Φ) Watts	Phase (Φ) VARs	PF	Power Factor Adder due to Phase Error, ±(%)		
			45 to 65 Hz	65 to 500 Hz	500 Hz to 1 kHz
0 °	90 °	1.000	0.00 %	0.03 %	0.38 %
10 °	80 °	0.985	0.08 %	0.50 %	-
20 °	70 °	0.940	0.16 %	0.99 %	-
30 °	60 °	0.866	0.25 %	1.55 %	-
40 °	50 °	0.766	0.37 %	2.23 %	-
50 °	40 °	0.643	0.52 %	3.15 %	-
60 °	30 °	0.500	0.76 %	4.57 %	-
70 °	20 °	0.342	1.20 %	7.23 %	-
80 °	10 °	0.174	2.48 %	14.88 %	-
90 °	0 °	0.000	-	-	-

Notes
 To calculate exact ac watts power factor adders due to phase error for values not shown, use the following formula:

$$Adder(\%) = 100 \left(1 - \frac{\cos(\Phi + \Delta\Phi)}{\cos(\Phi)} \right)$$

For example, for a PF of 0.9205 (Φ = 23) and a phase specification of ΔΦ = 0.15, the ac watts power factor adder is:

$$Adder(\%) = 100 \left(1 - \frac{\cos(23 + .15)}{\cos(23)} \right) = 0.11\%$$

Calculating Power Specifications

The Overall specification for power output in watts (or VARs) is based on the root sum square (rss) of the individual specifications in percent for the selected voltage, current, and power factor or VARs parameters:

Watts specification $Spec_{power} = \sqrt{Spec^2_{voltage} + Spec^2_{current} + Spec^2_{PFadder}}$

VARs specification $Spec_{VARs} = \sqrt{Spec^2_{voltage} + Spec^2_{current} + Spec^2_{VARsadder}}$

Because there are a tremendous number of combinations, you should calculate the actual power specification for your selected voltages and currents. The method of calculation is best shown in the following examples (using 1-year specifications):

Example 1 Output: 100 V, 1 A, 60 Hz, Power Factor = 1.0 (Φ=0), 1-year specifications

Voltage Specification Specification for 100 V at 60 Hz is 0.14 % + 18 mV, totaling: 100 V x 0.0014 = 140 mV added to 18 mV = 158 mV. Expressed in percent: 158 mV/100 V x 100 = 0.158 % (see "AC Voltage Specifications").

Current Specification Specification for 1 A at 60 Hz is 0.10 % + 1200 μA, totaling: 1 A x 0.001 = 1000 μA added to 1200 μA = 2.2 mA. Expressed in percent: 2.2 mA/1 A x 100 = 0.22 % (see "AC Current Specifications").

PF Adder Watts Adder for PF = 1 (Φ=0) at 60 Hz is 0 % (see "Phase Specifications").

$$Total\ Watts\ Output\ Specification = Spec_{power} = \sqrt{0.158^2 + 0.22^2 + 0^2} = 0.27\%$$

Example 2 Output: 100 V, 1 A, 50 Hz, Power Factor = 0.5 (Φ=60), 1-year specifications

Voltage Specification Specification for 100 V at 50 Hz is, 0.14 % + 18 mV, totaling: 100 V x 0.0014 = 140 mV added to 18 mV = 158 mV. Expressed in percent: 158 mV/100 V x 100 = 0.158 % (see "AC Voltage Specifications").

Current Specification Specification for 1 A is 0.10 % + 1200 μ A, totaling: 1 A x 0.001 = 1000 μ A added to 1200 μ A = 2.2 mA. Expressed in percent: 2.2 mA/1 A x 100 = 0.22 % (see "AC Current Specifications").

PF Adder Watts Adder for PF = 0.5 ($\Phi=60$) at 50 Hz is 0.76 % (see "Phase Specifications").

$$\text{Total Watts Output Specification} = \text{Spec}_{\text{power}} = \sqrt{0.158^2 + 0.22^2 + 0.76^2} = 0.81\%$$

VARs When the Power Factor approaches 0.0, the watts output specification becomes unrealistic because the dominant characteristic is the VARs (volts-amps-reactive) output. In these cases, calculate the Total VARs Output Specification, as shown in example 3:

Example 3 Output: 100 V, 1 A, 400 Hz, Power Factor = 0.174 ($\Phi=80$), 1-year specifications

Voltage Specification Specification for 100 V at 400 Hz is, 0.15 % + 18 mV, totaling: 100 V x 0.0015 = 150 mV added to 18 mV = 168 mV. Expressed in percent: 168 mV/100 V x 100 = 0.168 % (see "AC Voltage Specifications").

Current Specification Specification for 1 A at 400 Hz is 0.24 % + 1200 μ A, totaling: 1 A x 0.0024 = 2400 μ A added to 1200 μ A = 3.6 mA. Expressed in percent: 3.6 mA/1 A x 100 = 0.36 % (see "AC Current Specifications").

VARs Adder VARs Adder for $\Phi = 80$ at 400 Hz is 0.50 % (see "Phase Specifications").

$$\text{Total VARs Output Specification} = \text{Spec}_{\text{VARs}} = \sqrt{0.168^2 + 0.36^2 + 0.5^2} = 0.64\%$$

Frequency

Frequency Range	Resolution	Specification, tcal ± 5 $^{\circ}$ C, 1 year	Jitter
45.00 to 119.99 Hz	0.01 Hz	0.0050 % ± 2 mHz	4 μ s
120.0 to 1000.0 Hz	0.1 Hz		

Chapter 2

Operation Preparation

Title	Page
Introduction.....	2-3
Unpacking and Inspection.....	2-3
Replacing the Fuse.....	2-3
Selecting Line Voltage.....	2-4
Connecting to Line Power	2-4
Selecting Line Frequency	2-4
Service Information	2-6
Cooling Considerations.....	2-7
Accessories and Options	2-8
Rack Mount Considerations.....	2-8

Introduction

Warning

The 5080A Calibrator can supply lethal voltages. To avoid shock hazard, read this section before operating the Calibrator.

This chapter provides instructions for unpacking and installing the 5080A, selecting the line voltage, replacing the fuse, and connecting to line power. Instructions for cable connections other than line power can be found in the following chapters:

- UUT (Unit Under Test) connections: Chapter 4, “Front-Panel Operation”
- Ethernet interface connection: Chapter 5, “Remote Operation”
- RS-232 serial interface connection: Chapter 5, “Remote Operation”

Unpacking and Inspection

The Calibrator is shipped in a container designed to prevent damage during shipping. Inspect the Calibrator carefully for damage and immediately report any damage to the shipper. Instructions for inspection and claims are included in the shipping container.

When you unpack the Calibrator, check for all the standard equipment listed in Table 2-1 and check the shipping order for any additional items ordered. Report any shortage to the place of purchase or to the nearest Fluke Service Center (see “Service Information” in this section). A performance test is provided in Chapter 7, “Maintenance.”

If reshipping the Calibrator, use the original container. If it is not available, you can order a new container from Fluke by indicating the Calibrator's model and serial number.

Table 2-1. Standard Equipment

Item	Model or Part Number
Calibrator	5080A
Line Power Cord	See Table 2-2 and Figure 2-2
Test Lead Set	601721
USB to RS-232 Cable Adapter	3525836
5080A User Documentation CD (Operators and Getting Started Manuals)	3502934
5080A Getting Started Manual	3502941

Replacing the Fuse

Caution

To prevent possible damage to the instrument, verify the correct fuse is installed for the selected line voltage setting 100 V and 120 V, use 5.0 A/250 V time delay (slow blow); 220 V and 240 V, use 2.5 A/250 V time delay (slow blow).

The line power fuse is accessible on the rear panel. The fuse rating is 5 A/250 V slow blow for the 100 V/120 V line voltage setting; 2.5 A/250 V slow blow for the 220 V/240 V line voltage setting. Additional user replaceable fuses are discussed in Chapter 7, “Maintenance.”

To check or replace the fuse, refer to Figure 2-1 and proceed as follows:

1. **Disconnect line power.**

2. Open the fuse compartment by inserting a screwdriver blade in the tab located at the left side of the compartment and gently pry until it can be removed with the fingers.
3. Remove the fuse from the compartment for replacement or verification. Be sure the correct fuse is installed.
4. Reinstall the fuse compartment by pushing it back into place until the tab locks.

Selecting Line Voltage

The Calibrator arrives from the factory configured for the line voltage normally appropriate for the country of purchase, or as specified at the time of your purchase order. You can operate the 5080A Calibrator from one of four line voltage settings: 100 V, 120 V, 220 V, and 240 V (47 Hz to 63 Hz). To check the line voltage setting, note the voltage setting visible through the window in the power line fuse compartment cover (Figure 2-1). The allowed line voltage variation is 10 % above or below the line voltage setting.

To change the line voltage setting, complete the following procedure:

1. **Disconnect line power.**
2. Open the fuse compartment by inserting a screwdriver blade in the tab located at the left side of the compartment and gently pry until it can be removed with the fingers.
3. Remove the line voltage selector assembly by gripping the line voltage indicator tab with pliers and pulling it straight out of its connector.
4. Rotate the line voltage selector assembly to the desired voltage and reinsert.
5. Verify the appropriate fuse for the selected line voltage (100 V/120 V, use 5 A/250 V slow blow; 220 V/240 V, use 2.5 A/250 V slow blow) and reinstall the fuse compartment by pushing it back into place until the tab locks.

Connecting to Line Power

Warning

To avoid shock hazard, connect the factory supplied three-conductor line power cord to a properly grounded power outlet. Do not use a two-conductor adapter or extension cord. This will break the protective ground connection.

If there is any question about the effectiveness of instrument earth grounding through the line power cord ground wire, use the rear-panel AUX EARTH GROUND terminal for a protective grounding wire.

The Calibrator is shipped with the appropriate line power plug for the country of purchase. If you need a different type, refer to Table 2-2 and Figure 2-2 for a list and illustration of the line power plug types available from Fluke.

After you verify the line voltage selection is set correctly and the correct fuse for the selected line voltage is installed, connect the Calibrator to a properly grounded three-prong outlet.

Selecting Line Frequency

The Calibrator is shipped from the factory for nominal operation at 60 Hz line frequency. If you are using 50 Hz line voltage, you should re-configure the 5080A for optimal performance at 50 Hz. To do so from the front panel, go to SETUP, INSTMT SETUP, OTHER SETUP, and then select MAINS 50 HZ to “on”. Store the change. After the instrument is warmed up (on for 30 minutes or longer), you must re-zero the complete instrument. For details, see “Zeroing the Calibrator” in Chapter 4.

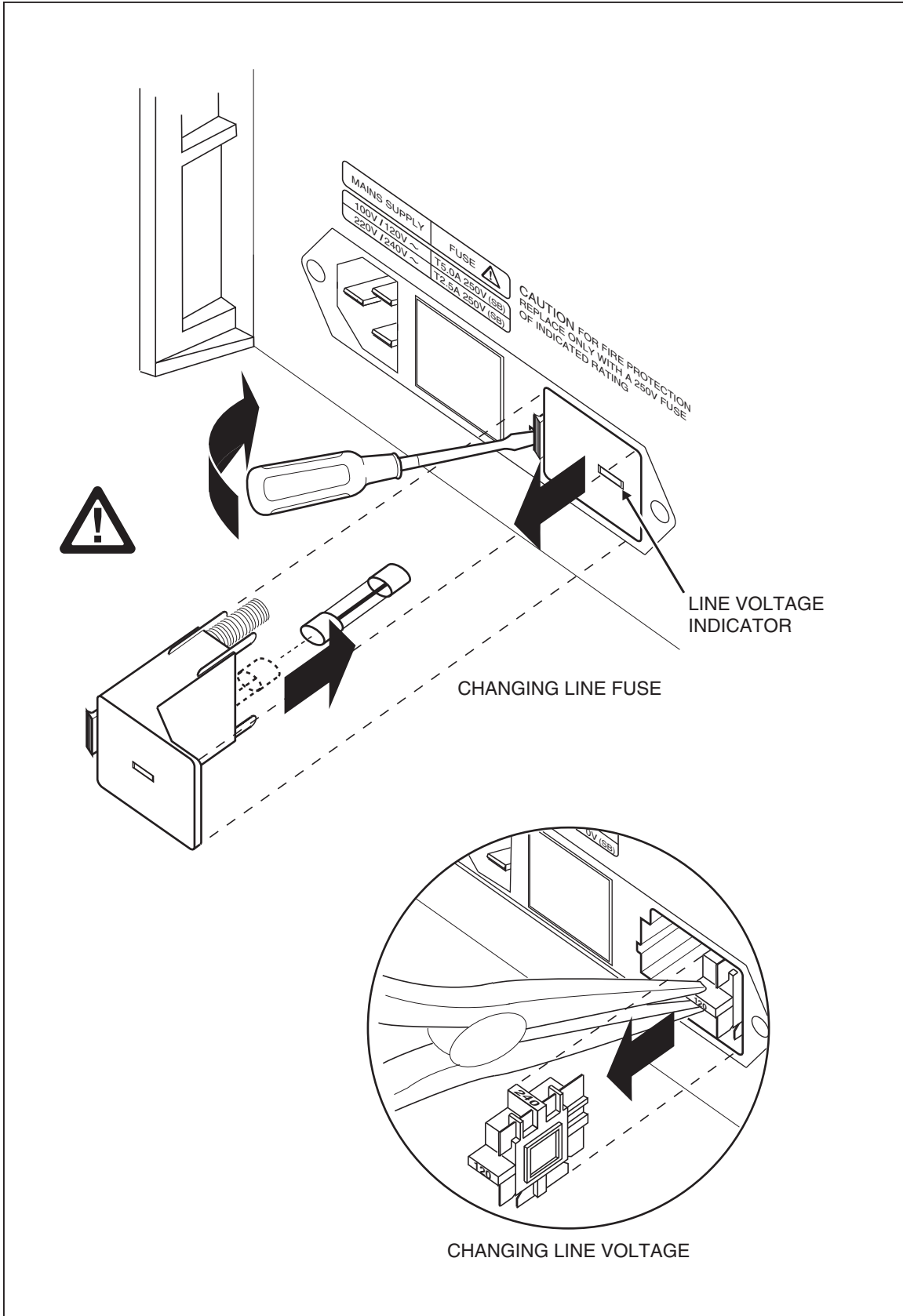

Figure 2-1. Fuse Access and Line Voltage Selection

nn007f.eps

Table 2-2. Line Power Cord Types Available from Fluke

Type	Voltage/Current	Fluke Option Number
North America	120 V/15 A	LC-1
North America	240 V/15 A	LC-2
Universal Euro	220 V/16 A	LC-3
United Kingdom	240 V/13 A	LC-4
Switzerland	220 V/10 A	LC-5
Australia	240 V/10 A	LC-6
South Africa	240 V/5 A	LC-7

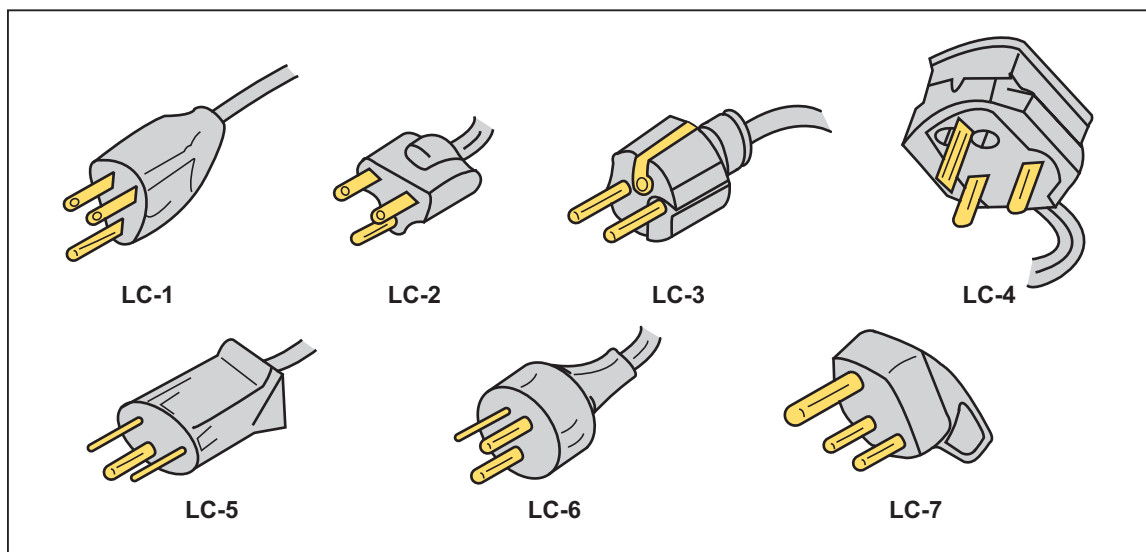

Figure 2-2. Line Power Cord Types Available from Fluke

nn008f.eps

Service Information

Each Model 5080A Calibrator is warranted to the original purchaser for a period of 1 year beginning on the date received. The warranty is located at the front of this manual.

To locate an authorized service center, call Fluke using any of the phone numbers listed below, or visit us on the World Wide Web: www.fluke.com.

USA:

Technical Support: 1-888-99-FLUKE (1-888-993-5853)

Calibration/Repair: 1-888-99-FLUKE(1-888-993-5853)

Canada: 1-800-36-FLUKE (1-800-363-5853)

China: +86-400-810-3435

Europe: +31 402-678-200

Japan: +81-3-3434-0181

Singapore: +65-738-5655

Anywhere in the world: +1-425-446-5500

After-warranty service is available, but you may choose to repair the Calibrator using the information in the Troubleshooting Chapter of the 5080A Service Manual and the Module Exchange Program. Refer to the Fluke catalog or contact a Fluke Service Center representative for the module exchange procedure.

Cooling Considerations

⚠ Warning

To avoid risk of injury, never operate or power the Calibrator without the fan filter in place.

⚠ Caution

Damage caused by overheating may occur if the area around the air intake or exhaust is restricted, the intake air is too warm, or the air filter becomes clogged.

Baffles direct cooling air from the fan through the chassis to dissipate heat during operation. The accuracy and dependability of all internal parts of the Calibrator are enhanced by maintaining the coolest possible internal temperature. You can lengthen the life of the Calibrator and enhance its performance by observing the following rules:

- The area around the air filter must be at least 3 inches from nearby walls or rack enclosures.
- The exhaust perforations on the sides of the Calibrator must be clear of obstructions.
- The air entering the instrument must be at room temperature. Make sure the exhaust air from another instrument is not directed into the fan inlet.
- Clean the air filter every 30 days, or more frequently if the Calibrator is operated in a dusty environment. (See Chapter 7, “Maintenance” for instructions on cleaning the air filter.)

Accessories and Options

Table 2-3 lists accessories and options available for the Calibrator.

Table 2-3. Accessories and Options

Accessory/Option	Fluke Model Part Number
5080A Service Manual	3790039
Oscilloscope Calibration Option ^[1]	5080A-SC
MegOhm Meter Calibration Option ^[1]	5080A-MEG
Transit Case with Wheels	5080A/CASE
Double Banana Plug Adapter	105825
5 A/250 V Time Delay Fuse (mains fuse for 100 V/120 V line voltage)	109215
2.5 A/250 V Time Delay Fuse (mains fuse for 200 V/240 V line voltage)	851931
4 A/500 V Fuse (AUX current output fuse)	3674001
25 A/250 V Fuse (20A current output fuse)	3470596
RS-232 Interface Cable	RS43
Ethernet Internet Cable	884X-ETH
Calibration Software for Automated Calibration with 5080A	5080/CAL
License disk for MET/CAL. Automated Calibration software. MET/BASE-5 or later required.	MET/CAL-L
License disk upgrade. MET/BASE-7U and prior version of MET/CAL required.	MET/CAL-LU
Asset Management Software. MET/BASE-5 or later required	MET/TRACK
System engine. Requires licenses for one or more client applications (MET/CAL-L, and/or MET/TRACK)	MET/BASE
Manual Calibration Software. MET/BASE and MET/TRACK required.	Manual MET/CAL
^[1] Options can be ordered factory installed with a new calibrator (5080A/MEG, 5080A/SC, and 5080A/SC/MEG), or added later at a Fluke service center for an additional installation and calibration charge.	

Rack Mount Considerations

Rack mount the Calibrator using a support shelf or drawer. The Calibrator chassis is not designed for use with front-mounted rack ears or side-mounted rack slides.

Warning

Do not restrict access to the Calibrator power cord, which is the mains disconnecting device. If access to the power cord is inhibited by rack mounting, a properly rated accessible proximate mains disconnecting switch must be provided as part of the installation.

Chapter 3

Features

Title	Page
Introduction.....	3-3
Front-Panel Features	3-3
Rear-Panel Features	3-3
Softkey Menu Trees.....	3-3

Introduction

This chapter is a reference for the functions and locations of the 5080A Calibrator's front- and rear-panel features. Please read this information before operating the Calibrator. Front-panel operating instructions for the Calibrator are provided in Chapter 4, “Front-Panel Operation”; remote operating instructions are provided in Chapter 5, “Remote Operation.”

Front-Panel Features

Front-panel features (including all controls, displays, indicators, and terminals) are shown in Figure 3-1. Each front-panel feature is described in Table 3-1.

Rear-Panel Features

Rear-panel features (including all terminals, sockets, and connectors) are shown in Figure 3-2. Each rear-panel feature is described in Table 3-2.

Softkey Menu Trees

The Setup softkeys are identified in Figures 3-3 and 3-4. The Setup softkeys are associated with the 5080A Calibrator front-panel  key. The functions of the five softkeys are identified by label information displayed directly above each key. The softkey labels change during operation so that many different functions are quickly accessible.

A group of softkey labels is called a menu. A group of interconnected menus is called a menu tree. Figure 3-3 shows the SETUP menu tree structure. Figure 3-4 describes each SETUP menu tree display. Table 3-3 shows the factory default settings for the SETUP menu tree. To return the SETUP menus to their default values, use the softkey SETUP in the Format NV Memory menu (see Figure 3-4, menu F).

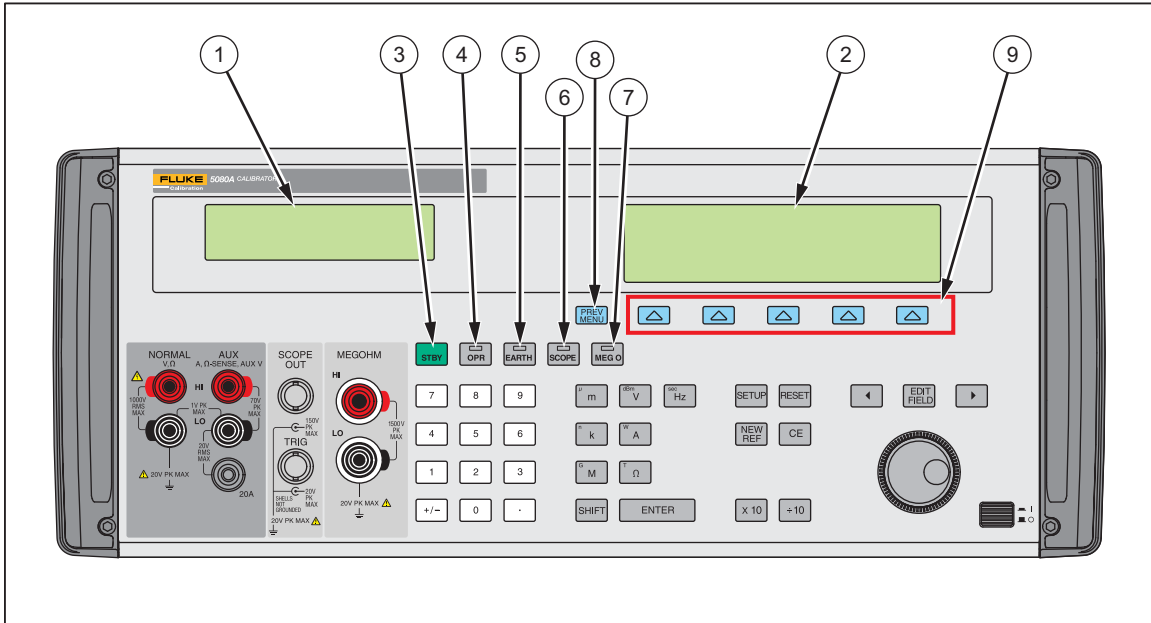

Figure 3-1. Front-Panel View

gew322f.eps

Table 3-1. Front-Panel Features

1	<p>Output Display</p> <p>The Output Display is a two-line backlit LCD that shows output amplitudes, frequency and Calibrator status. Output values (or potential output values if in standby) are displayed using up to six digits plus a polarity sign. Output frequencies (or potential output frequencies if the 5080A is in standby) are displayed using four digits. Calibrator status is indicated by displaying the following abbreviations:</p> <p>OPR Displayed when an output is active at the front-panel terminals.</p> <p>STBY Displayed when the 5080A is in standby.</p> <p>u When you change the output, a “u” (unsettled) is displayed until the output settles to within the specified accuracy.</p> <p>C Displayed when unstored calibration constants are in use.</p>
2	<p>Control Display</p> <p>The Control Display is a multipurpose backlit LCD used for displaying data entries, UUT error adjustments, softkey labels, phase angles, watts, power factors, and other prompts and messages. When there isn't enough room on the Output Display, output frequency is displayed on the Control Display. Softkey labels identify the function of the softkey directly below them. Several softkey labels together are called a menu. The changing menus provide access to many different functions through the five softkeys plus the PREV MENU key. (See Figure 3-3, Softkey Menu Tree.)</p>

Table 3-1. Front-Panel Features (cont.)

3	<div style="display: flex; align-items: center; margin-bottom: 5px;"> STBY </div> <p>The STBY (Standby) key places the 5080A in standby mode. Standby mode is indicated by “STBY” in the lower left corner of the Output Display. In standby mode, the NORMAL, AUX and 20A output terminals are internally disconnected from the 5080A. The 5080A starts up in standby mode. The 5080A automatically switches to standby if one of the following occurs:</p> <ul style="list-style-type: none"> The RESET key is pressed. A voltage ≥ 33 V is selected when the previous output voltage was less than 33 V. The output function is changed, except when going between ac or dc voltage <33 V. The current output changes from 20A output to AUX output or from AUX output to 20A output. The current is changed from ac to dc or from dc to ac. An overload condition is detected.
4	<div style="display: flex; align-items: center; margin-bottom: 5px;"> OPR </div> <p>The OPR (Operate) key places the 5080A in operate mode. Operate mode is indicated by “OPR” in the lower left corner of the Output Display and the lit indicator on the OPR key.</p>
5	<div style="display: flex; align-items: center; margin-bottom: 5px;"> EARTH </div> <p>The EARTH (Earth Ground) key opens and closes an internal connection between the NORMAL LO terminal and earth ground. An indicator on the key indicates when this connection is made. The power-up default condition is earth disabled (indicator off).</p>
6	<div style="display: flex; align-items: center; margin-bottom: 5px;"> SCOPE </div> <p>The SCOPE (Oscilloscope) key activates or deactivates an oscilloscope calibration option if it is installed. An indicator on the key indicates when the option is activated. If an oscilloscope calibration option is not installed in the Calibrator and the SCOPE key is pressed, the Calibrator displays an error message.</p>
7	<div style="display: flex; align-items: center; margin-bottom: 5px;"> MEG O </div> <p>The MEG O (Megohm) key activates or deactivate the megohm calibration option if it is installed. An indicator on the key indicates when the option is activated. If the megohm calibration option is not installed in the Calibrator and the MEG O key is press, the Calibrator displays an error message.</p>
8	<div style="display: flex; align-items: center; margin-bottom: 5px;"> PREV MENU </div> <p>The PREV MENU (Previous Menu) key recalls the previous set of menu choices. Each press of this key backs up one level of the menu tree until the display indicates the top level menu selection of the function selected.</p>
9	<p>Softkeys</p> <p>The functions of the five unlabeled blue softkeys are identified by labels on the Control Display directly above each key. The functions change during operation so that many different functions are accessible through these keys. A group of softkey labels is called a menu. A group of interconnected menus is called a menu tree.</p>

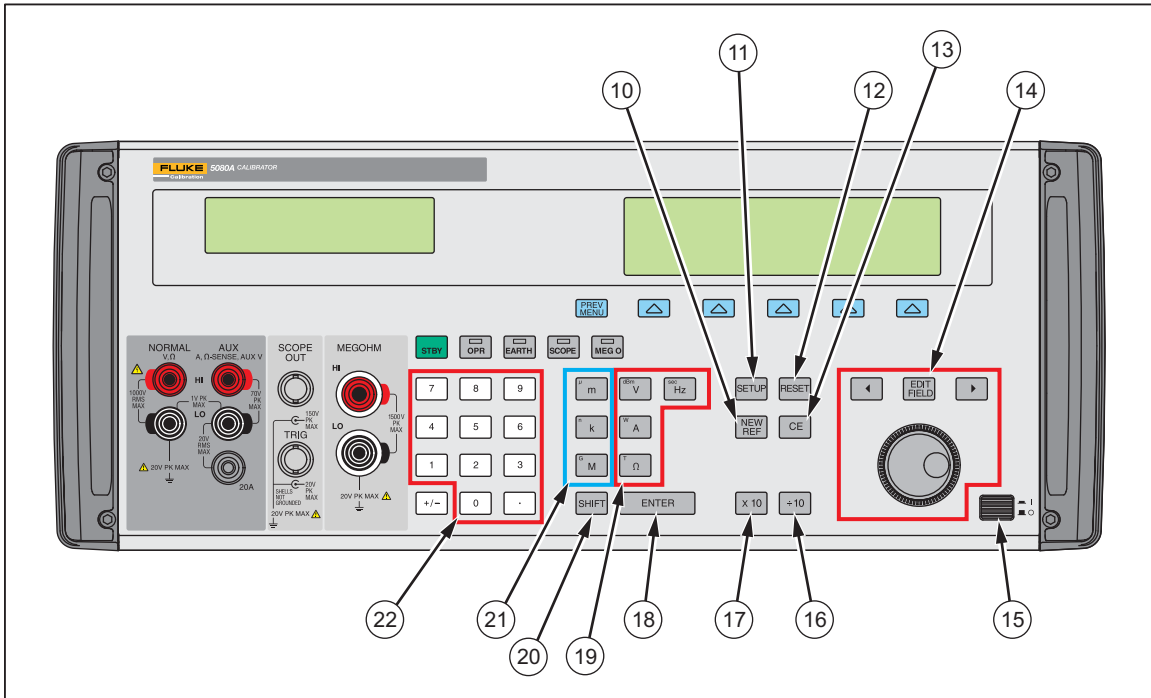

Figure 3-1. Front-Panel View (cont.)

gew324f.eps

Table 3-1. Front-Panel Features (cont.)



























10	<p> NEW REF (New Reference) key is active during error mode operation, and establishes the present output value as a new reference for meter error computation.</p>
11	<p> SETUP (Setup Menu) key puts the 5080A in the setup mode, displaying the setup menu in the Control Display. Setup options can be selected using the softkeys under the Control Display.</p>
12	<p> RESET (Reset Calibrator) key aborts the current operating state of the 5080A and returns it to the power-up default state, except when operating under remote control.</p>
13	<p> CE (Clear Entry) key clears a partially completed keypad entry from the Control Display. If there is a partially completed entry when CE is pressed, the output is unaffected.</p>
14	<p> EDIT FIELD (Edit Output Display Field) key and associated left/right arrow keys provide step adjustment of the output signals. If any of these keys are pressed or the knob is rotated, a digit on the Output Display becomes highlighted and the output increments or decrements as the knob is rotated. If a digit rolls past 0 or 9, the digit to its left or right is carried. An error display appears on the Control Display, showing the difference between the original (reference) output and the new output.</p>
15	<p>The  and  keys adjust the magnitude of changes by moving the highlighted digit. The  key allows you to move from voltage or current to frequency and back. In practice, for voltage and current outputs, the knob and arrow keys are used to adjust output until the UUT reads correctly. The error display then displays UUT deviation from the reference.</p> <p>The power switch turns the power on and off. The switch is a latching push-push type. When the switch is latched in, power is on.</p>

Table 3-1. Front-Panel Features (cont.)

16	<p> The divide by 10 key immediately changes the output to 1/10th reference value (not necessarily the present output value) if the value is within performance limits.</p>
17	<p> The multiply by 10 key immediately changes the output to 10X the reference value (not necessarily the present output value) if the value is within performance limits. This key sets the 5080A to standby if this change is from a value <33 V to a value ≥33 V.</p>
18	<p> The ENTER key loads a newly entered output value shown on the Control Display into the 5080A, which appears on the Output Display. The new value can come from the numeric keypad. If you press ENTER without identifying the units for the entry, in most cases the 5080A keeps the units that were last used. This allows you, for example, to enter 1 mV, and then later enter 10 to obtain 10 V. (The "V" units were saved from the last entry, but not the multiplier, "m".) In the Error (edit) mode, ENTER with no value restores the output to the value of the reference.</p>
19	<p>Output Units Keys</p> <p>The output units keys determine the function of the 5080A. Some keys have a second unit if the SHIFT key is pressed just before the units key. The output units are as follows:</p> <ul style="list-style-type: none">  Volts or Decibels relative to 1 mW into 600 ohms (impedance changeable).  Watts or amperes  Ohms  Frequency or seconds <p>When a non-zero frequency (Hz) value is entered, the 5080A automatically switches to ac. When a new signed (+ or –) output value is entered without specifying Hz, the 5080A automatically switches back to dc (or enter "0" Hz to move back to volts dc).</p>
20	<p> The SHIFT key selects alternate functions of the units keys and alternate multipliers of the multiplier keys. These alternate selections are labeled with small letters in the upper left hand corner of the keys.</p>
21	<p>Multiplier Keys</p> <p>Select output value multipliers. Some keys have a second function if the SHIFT key is pressed just before the multiplier key. For example, if you enter 33, then SHIFT, then , then , then ENTER, the 5080A output value is 33 μV. The multiplier keys are as follows:</p> <ul style="list-style-type: none">  milli (10⁻³ or 0.001) or micro (10⁻⁶ or 0.000001)  kilo (10³ or 1,000) or nano (10⁻⁹ or 0.000000001)  mega (10⁶ or 1,000,000) or giga (10⁹ or 1,000,000,000)
22	<p>Numeric Keypad</p> <p>Used to enter the digits of the output amplitude and frequency. The proper sequence to enter a value is to press the digits of the output value, a multiplier key (if necessary), an output units key, then ENTER. For example, to obtain an output of 20 mV, press the following sequence of keys: , , , and . Press  to enable the output. Pressing a digit key once the entry field is full, or pressing the decimal point key more than once in a single number, will sound the beeper.</p>

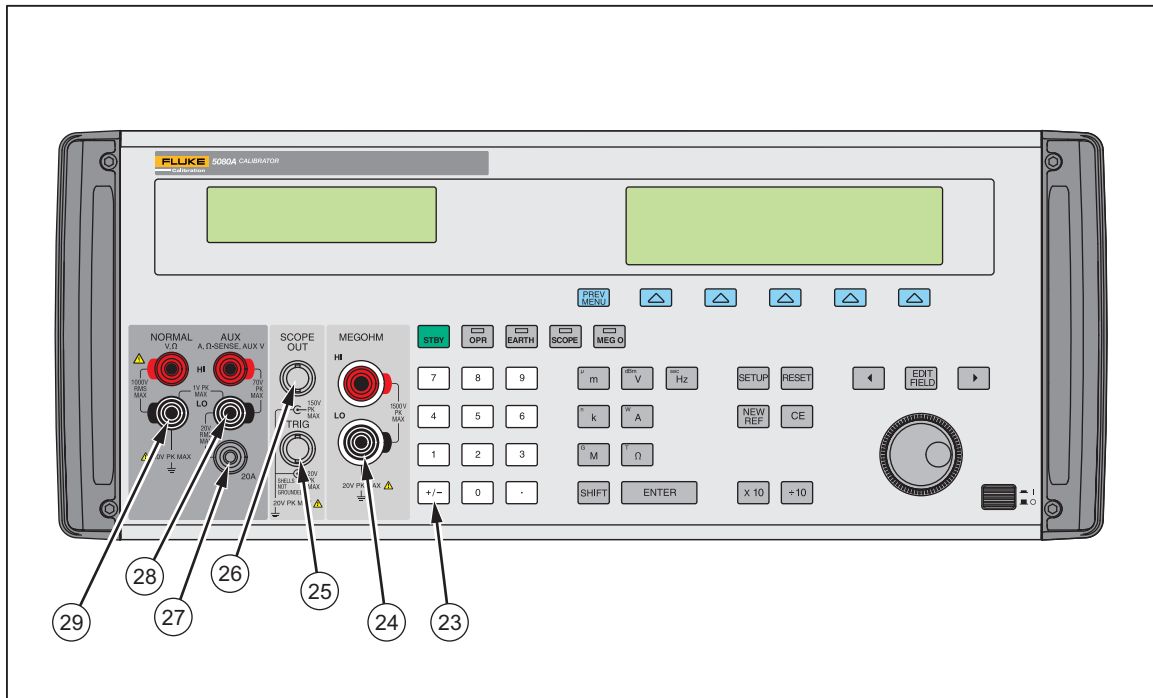

Figure 3-1. Front-Panel View (cont.)

gew325f.eps

Table 3-1. Front-Panel Features (cont.)

23	+/-	The +/- (Polarity) key changes the polarity of the output for dc voltage or dc current functions. Press the +/- key then ENTER to toggle the output polarity.
24	MEG OHM	The MegOhm terminals are used for high resistance sourcing. This button is active only when a MegOhm option is installed.
25	SCOPE TRIG	The SCOPE TRIG (Scope Trigger) BNC connector is used to trigger the oscilloscope during oscilloscope calibration. This is active only when an oscilloscope option is installed.
26	SCOPE OUT	The SCOPE OUT (Oscilloscope) BNC connector is used for outputs during oscilloscope calibration. This is active only when an oscilloscope calibration option is installed.
27	20A	The 20A terminal is the source of current output when the 20 A range is selected (3 A - 20 A).
28	AUX	The AUX (Auxiliary Output) terminals are used for ac and dc current outputs, the second voltage output in dual voltage modes, and ohms sense for 2-wire and 4-wire compensated resistance.
29	NORMAL	The NORMAL (Normal Output) terminals are used for ac and dc voltage, ohms.

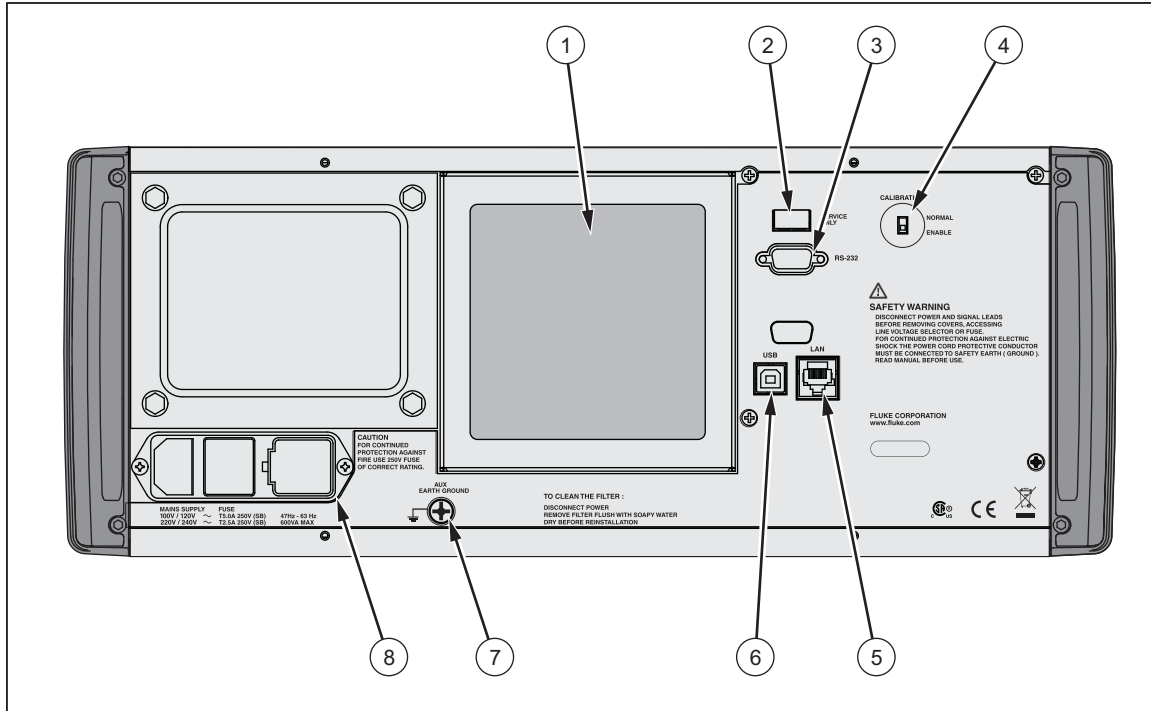



Figure 3-2. Rear-Panel View

gew323.eps

Table 3-2. Rear-Panel Features

①	The Fan Filter covers the air intake to keep dust and debris out of the chassis air baffles. The 5080A fan provides a constant cooling air flow throughout the chassis. Instructions for fan filter maintenance are in Chapter 7, Maintenance.
②	Service use only.
③	The RS-232 Port provides a communication channel that allows the Calibrator to be controlled by sending it commands.
④	Calibration switch.
⑤	The Ethernet Port provides a communication channel that allows the Calibrator to be controlled by sending it commands.
⑥	Service use only.

Table 3-2. Rear-Panel Features (cont.)

<p>7</p>	<p style="text-align: center;"> Warning</p> <p>To avoid shock hazard, connect the factory supplied three-conductor line power cord to a properly grounded power outlet. Do not use a two-conductor adapter or extension cord; this will break the protective ground connection.</p> <p>If there is any question about the effectiveness of instrument earth grounding through the line power cord ground wire, use the rear-panel AUX EARTH GROUND terminal for a protective grounding wire.</p> <p>The AUX EARTH GROUND terminal is internally grounded to the chassis. If the 5080A is the location of the ground reference point in a system, this binding post can be used for connecting other instruments to earth ground. Refer to “Connecting the Calibrator to a UUT” in Chapter 4, “Front-Panel Operation” for details.</p>
<p>8</p>	<p>The AC Power Input Module provides a grounded three-prong connector that accepts the line power cord, a switch mechanism to select the operating line voltage, and a line power fuse. See Chapter 2, “Preparing for Operation” for information on selecting the operating line voltage, and fuse rating and replacement information.</p>

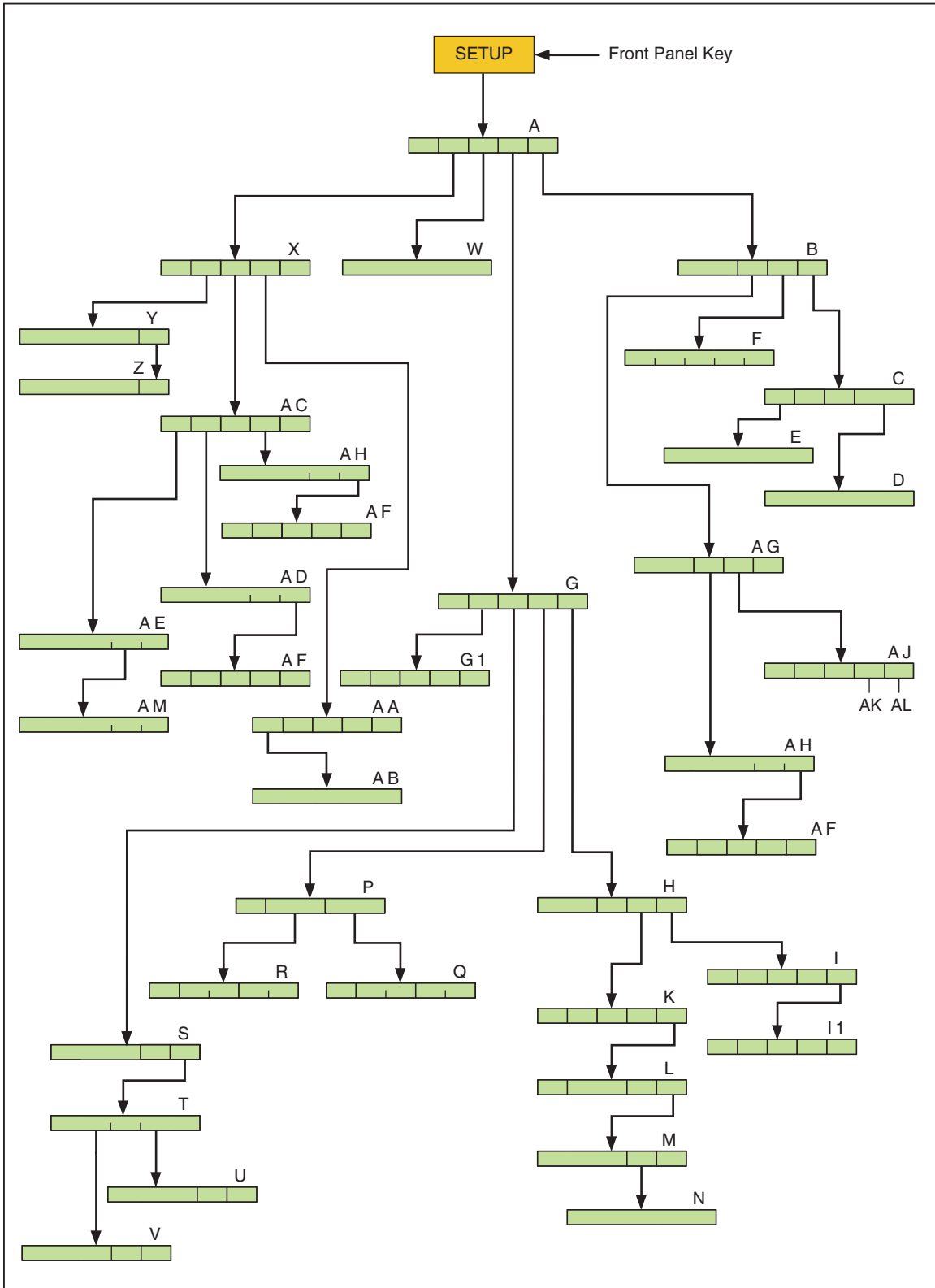
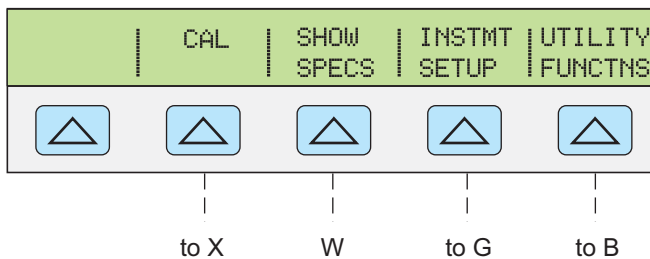

Figure 3-3. SETUP Softkey Menu Tree

gew013f.eps

A



SHOW SPECS is an online summary of the programmed output specifications.

B

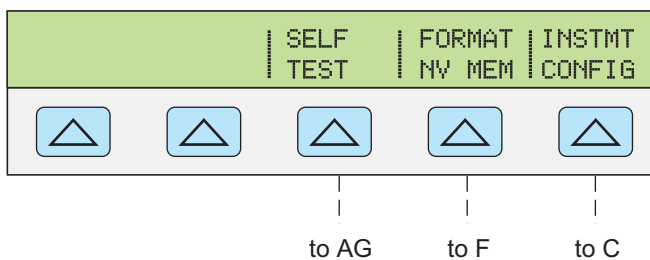

If self test does not pass, error codes are displayed. (See chapter 7, "Maintenance")

C

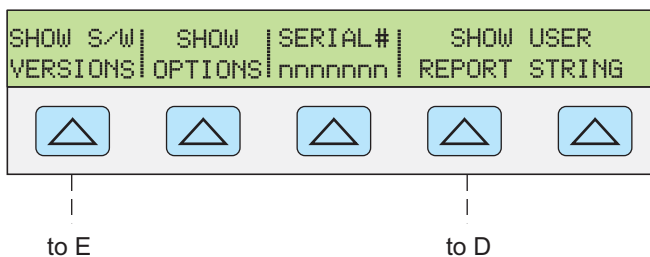

SERIAL # displays the serial number of the instrument. When corresponding with the factory, always include the serial number of the instrument.

D

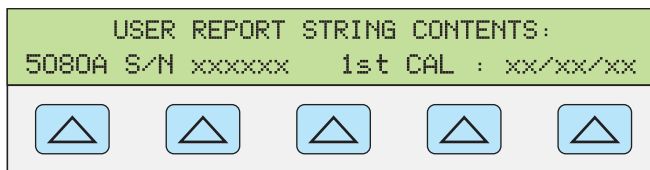

USER REPORT STRING CONTENTS refer to a string of characters entered by the user for reporting purposes.

Figure 3-4. SETUP Softkey Menu Displays

gew014.eps

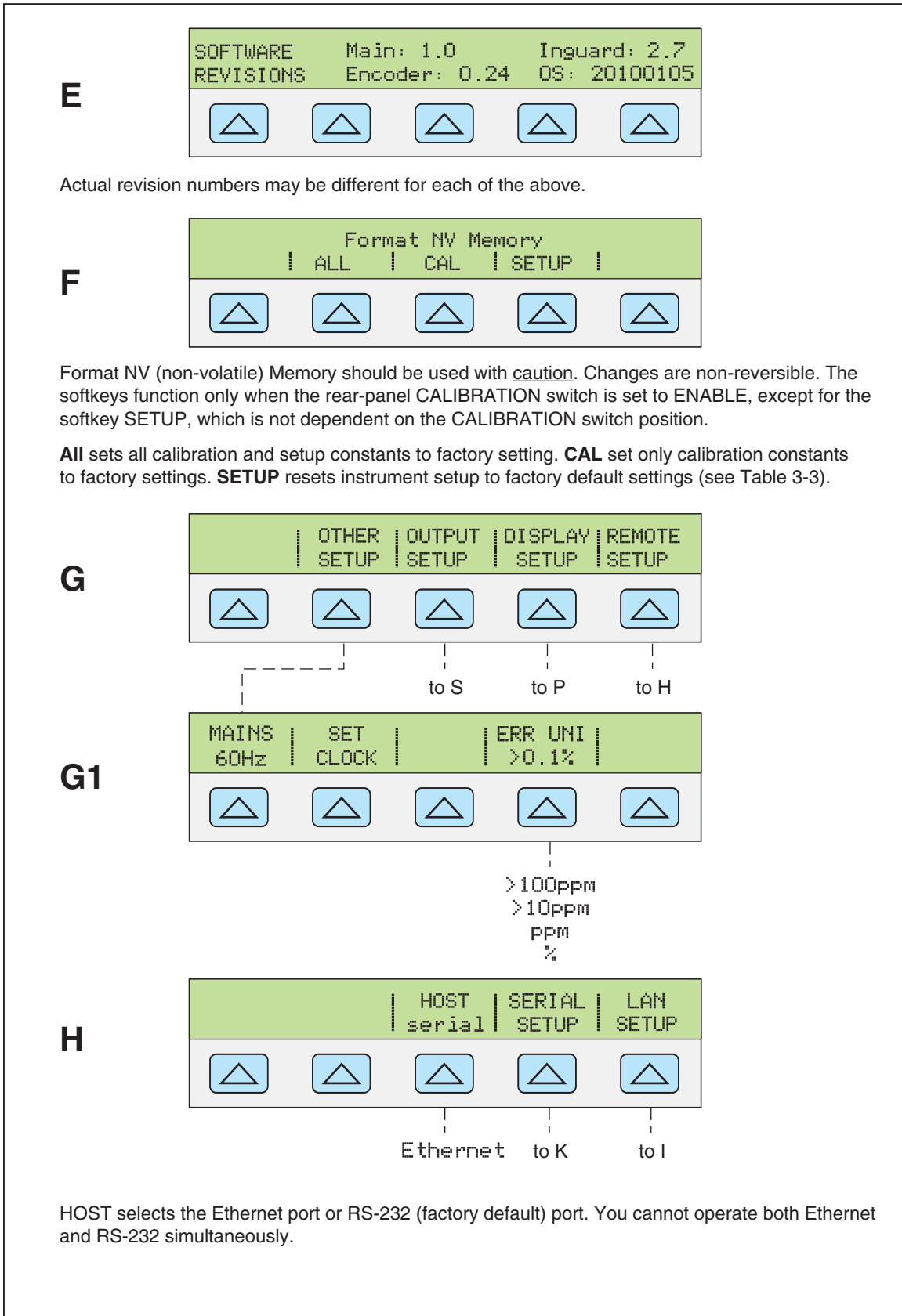

gew015.eps

Figure 3-4. SETUP Softkey Menu Displays (cont.)

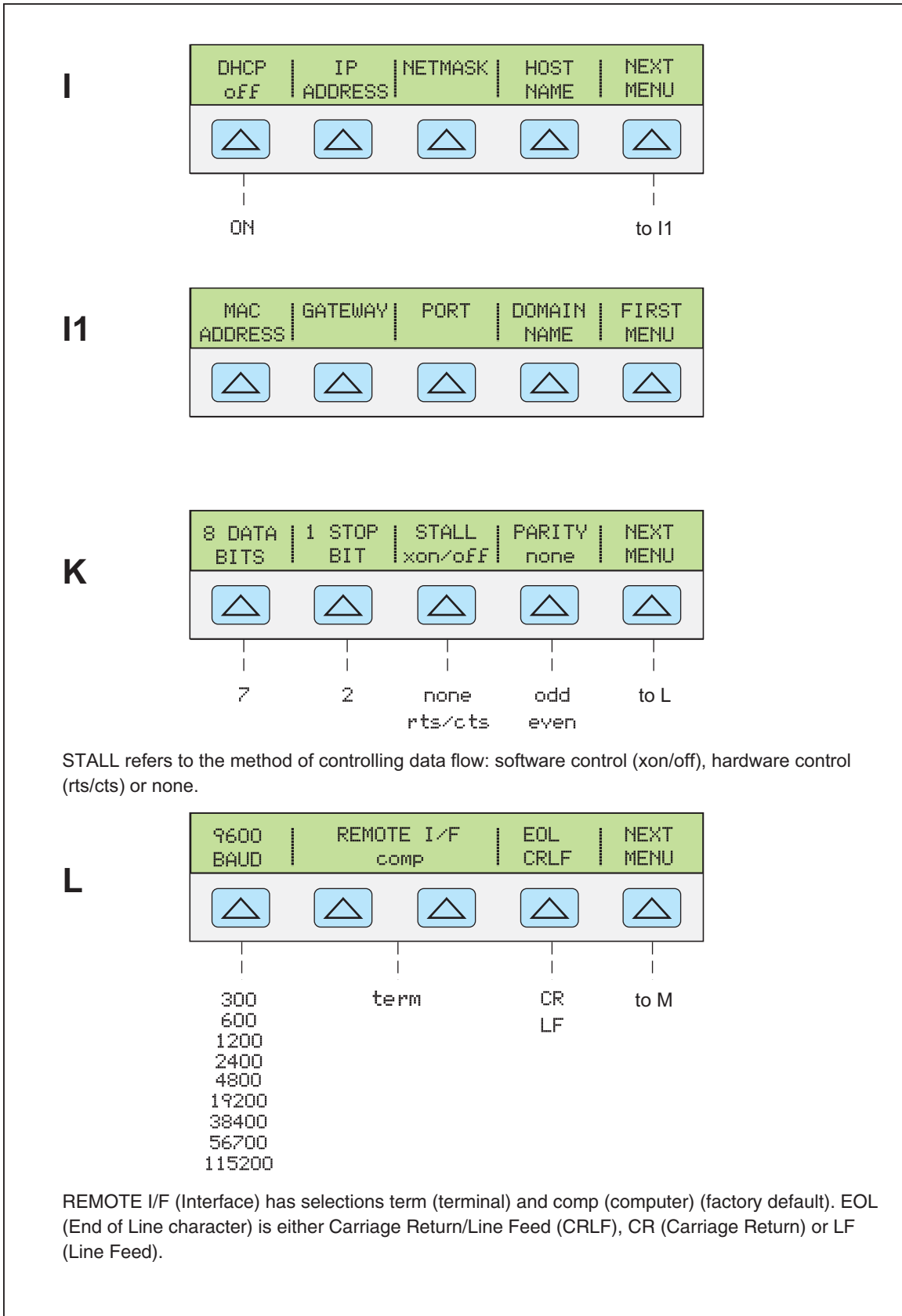

Figure 3-4. SETUP Softkey Menu Displays (cont.)

gew016.eps

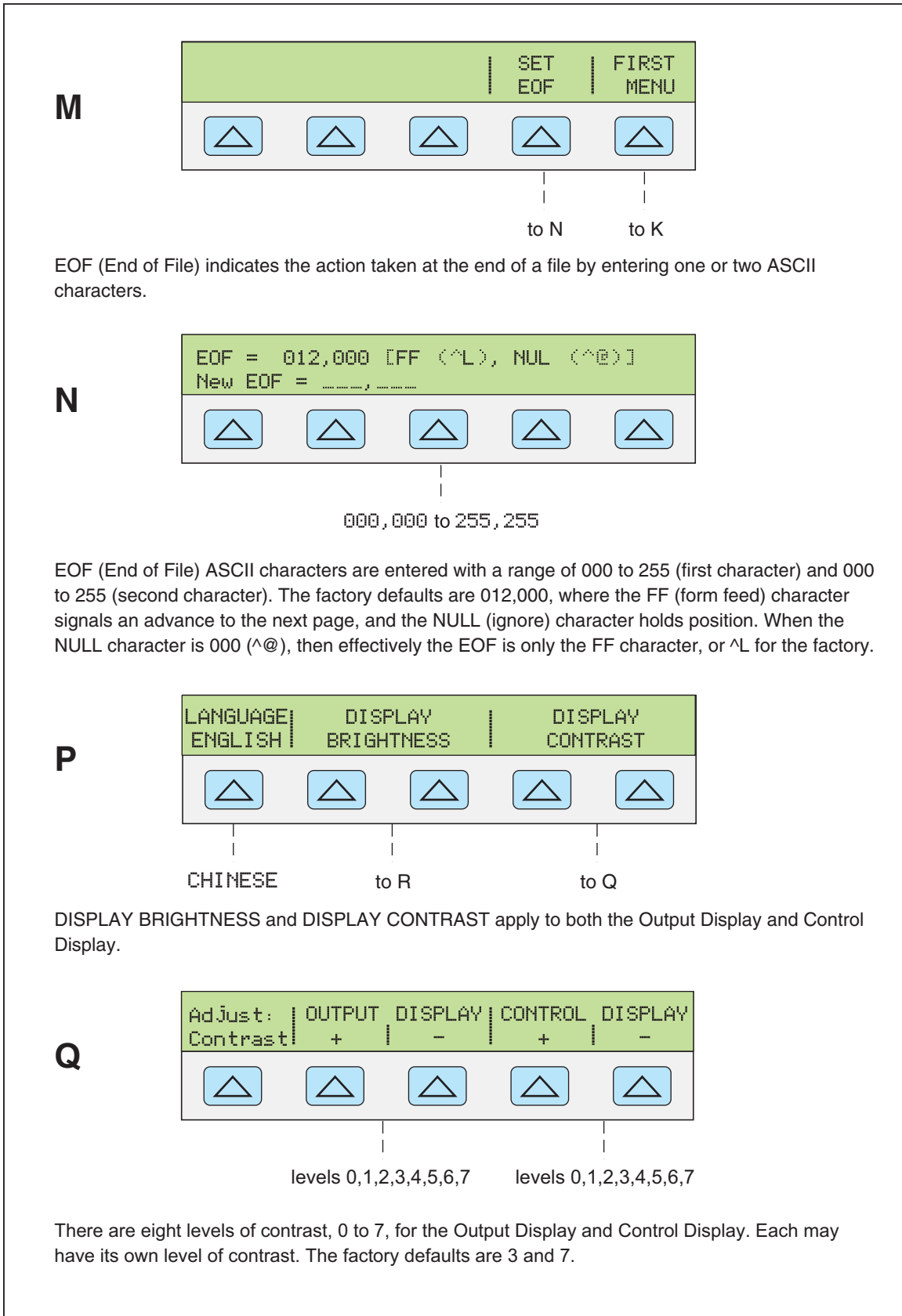

Figure 3-4. SETUP Softkey Menu Displays (cont.)

gew017.eps

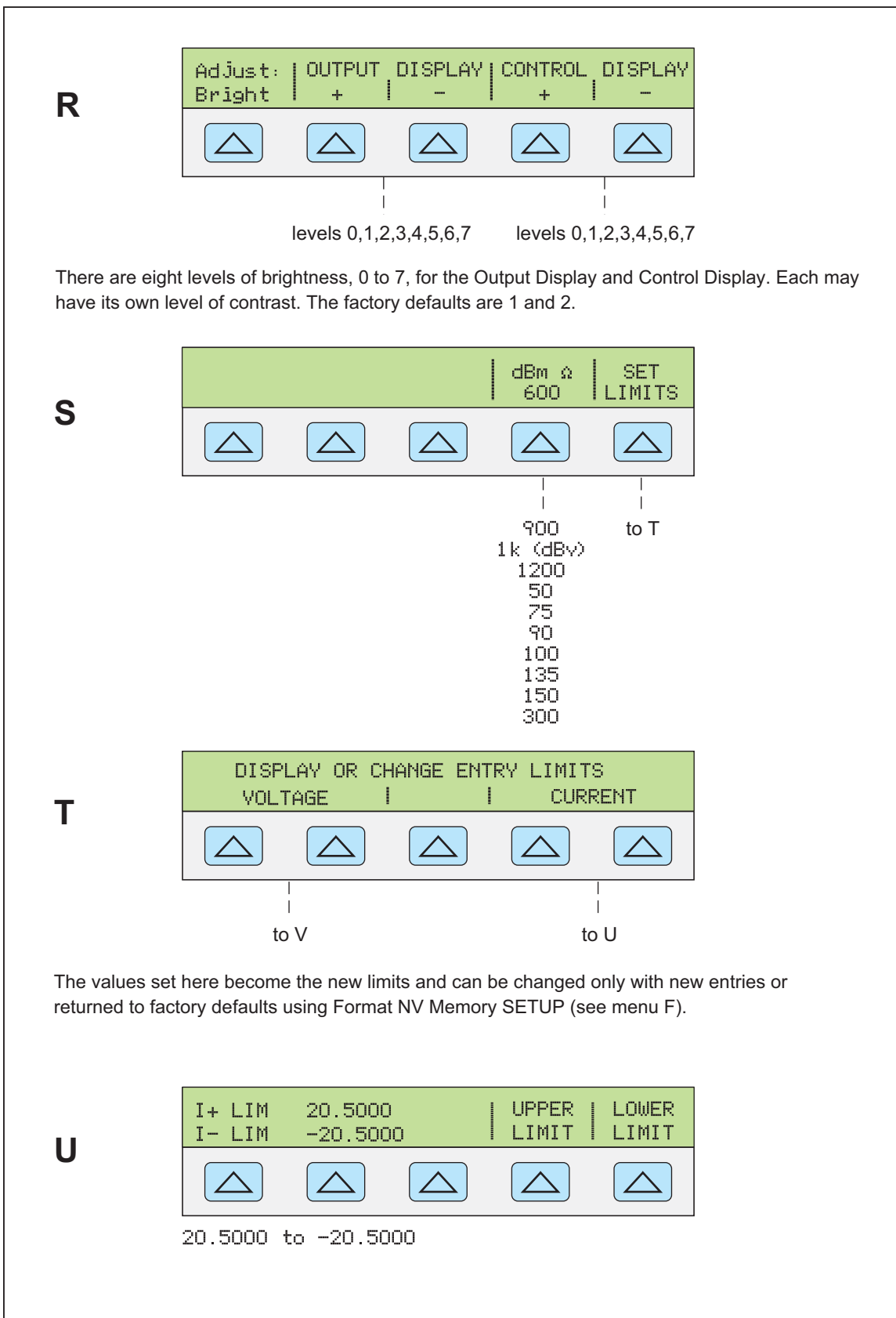

Figure 3-4. SETUP Softkey Menu Displays (cont.)

gew018.eps

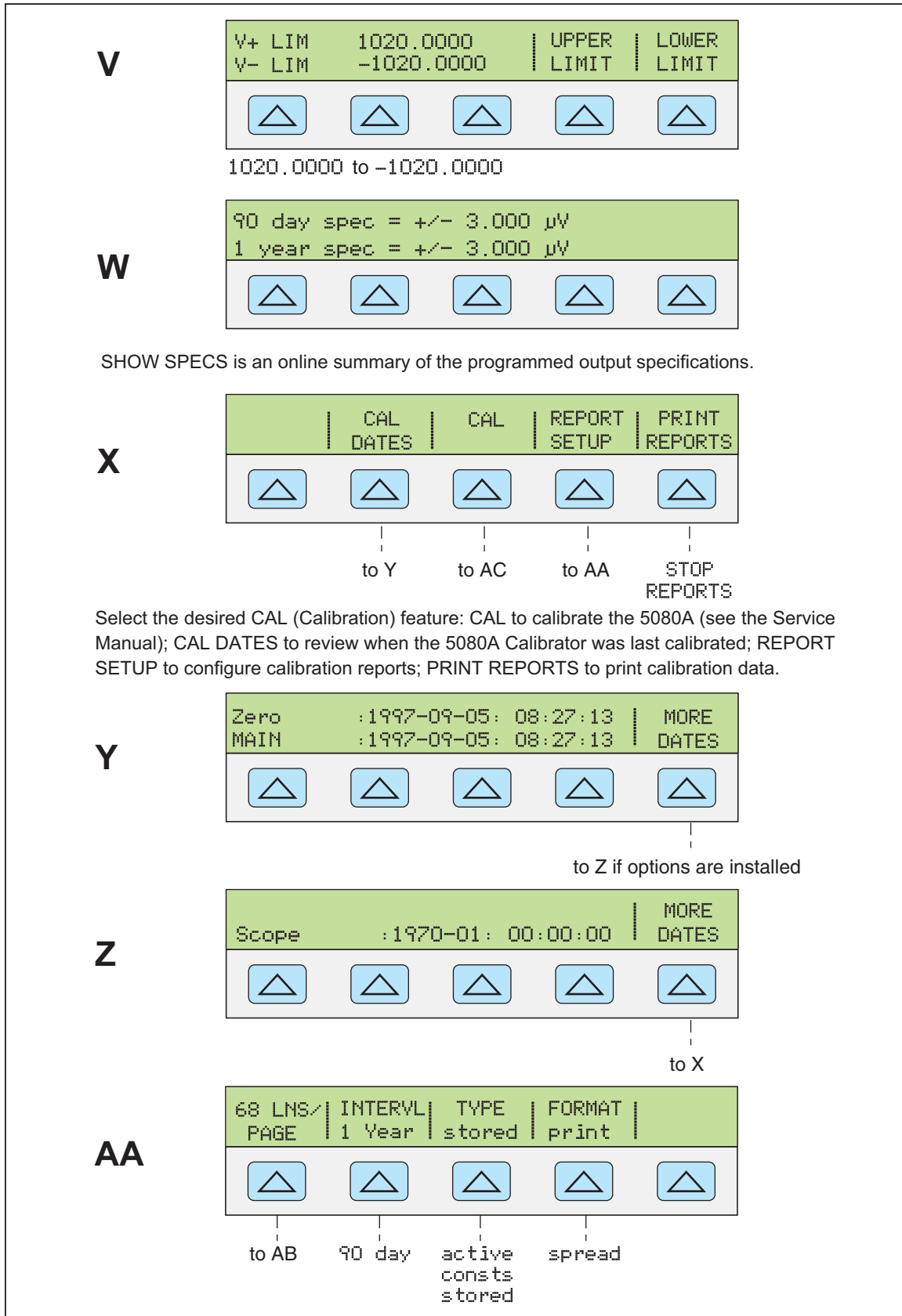

Figure 3-4. SETUP Softkey Menu Displays (cont.)

gew020.eps

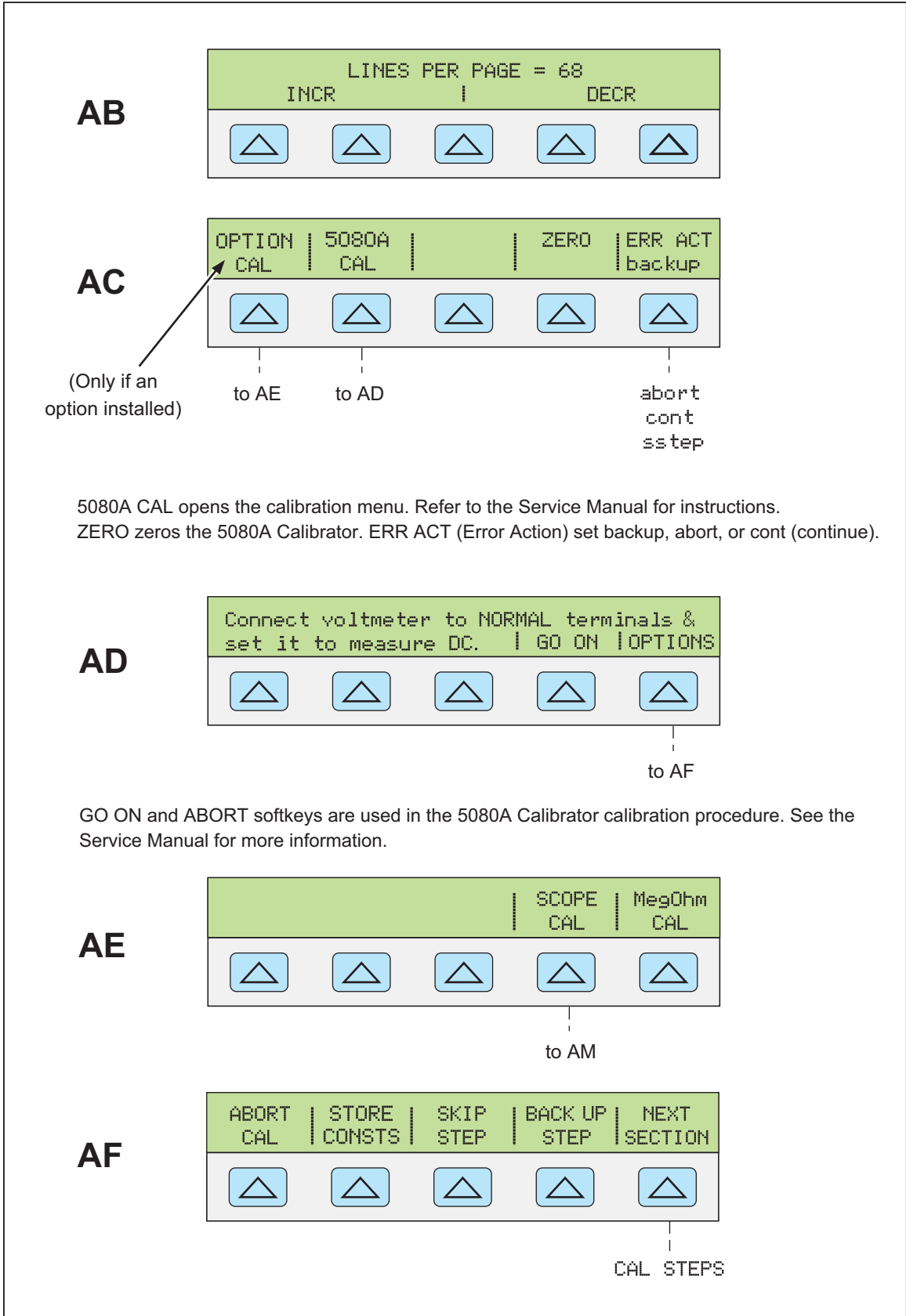

Figure 3-4. SETUP Softkey Menu Displays (cont.)

gew021.eps

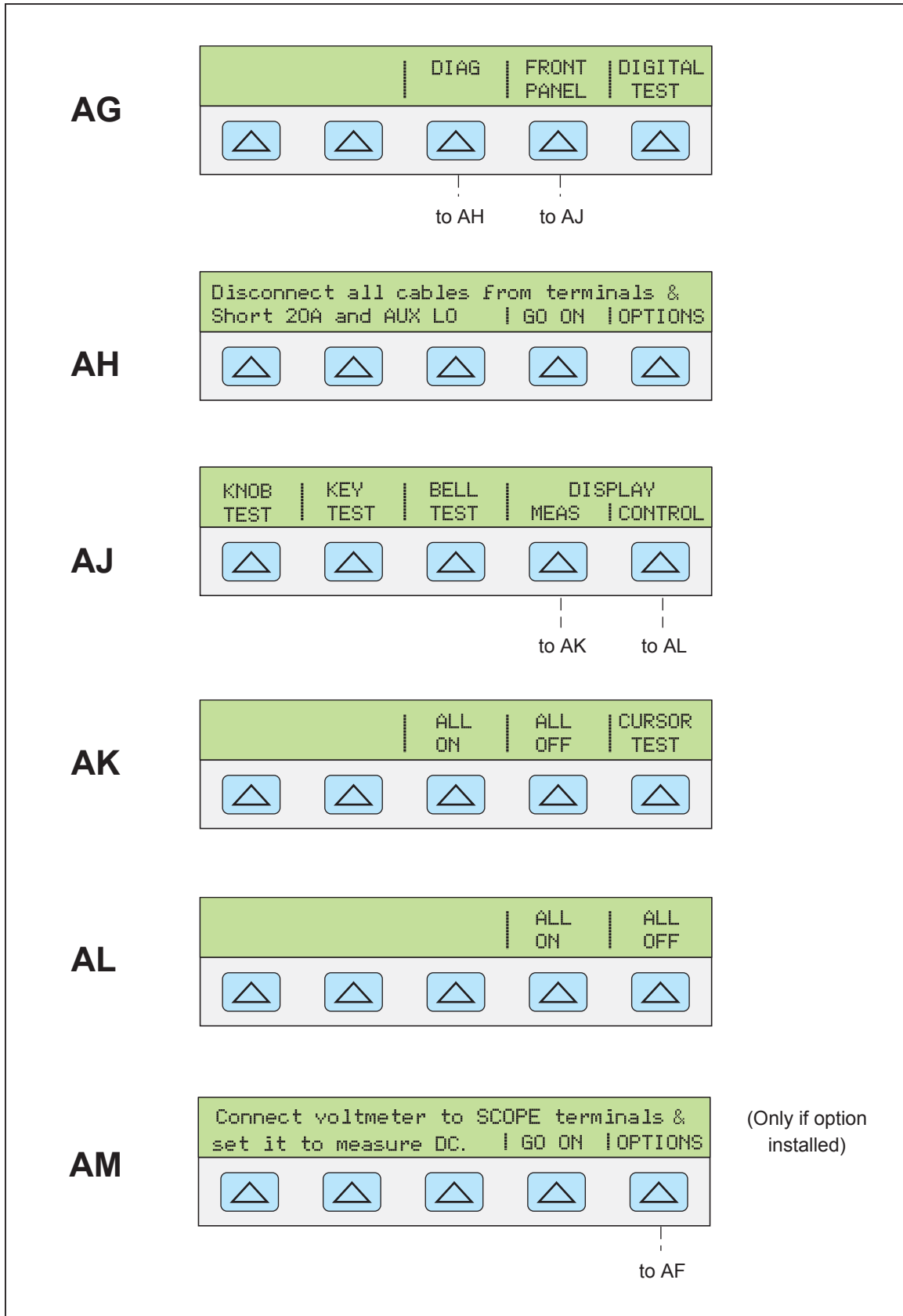

Figure 3-4. SETUP Softkey Menu Displays (cont.)

gew022.eps

Table 3-3. Factory Defaults for SETUP Menus Power-Up Defaults

Parameter	Setting	Setup from Figure 3-4
User report string (*PUD string)	Cleared	D
Error units	>0.1 %	G1
Host interface	RS-232	H
Host serial interface	comp, 8 bits, 1 stop bit, xon/xoff, parity none, 9600 baud, CRLF, 012,000	K, L, M, N
Display brightness ^[1]	level 1,2	P
Display contrast ^[1]	level 3,7	P
dBm impedance	600 Ω	S
Current limits	± 20.5 A	U
Voltage limits	± 1020 V	V
[1] Output display and control display, respectively. There are 8 levels: 0, 1, 2, 3, 4, 5, 6, 7.		



Chapter 4

Front-Panel Operations

Title	Page
Introduction.....	4-3
Turning on the Calibrator.....	4-3
Warming up the Calibrator	4-3
Using the Softkeys.....	4-4
Using the Setup Menu.....	4-4
Using the Instrument Setup Menu.....	4-5
Utility Functions Menu.....	4-5
Using the Format NV Memory Menu	4-6
Resetting the Calibrator	4-6
Zeroing the Calibrator.....	4-6
Using the Operate and Standby Modes.....	4-7
Connecting the Calibrator to a UUT	4-8
Recommended Cable and Connector Types.....	4-8
When to Use EARTH.....	4-9
Four-Wire versus Two-Wire Connections	4-9
Cable Connection Instructions.....	4-10
Auto Range Versus Locked Range.....	4-12
Setting the Output.....	4-13
Setting DC Voltage Output	4-13
Setting AC Voltage Output	4-14
Setting DC Current Output.....	4-16
Setting AC Current Output.....	4-17
Setting DC Power Output.....	4-18
Setting AC Power Output.....	4-20
Setting a Dual DC Voltage Output.....	4-22
Setting a Dual AC Voltage Output.....	4-24
Setting Resistance Output.....	4-27
Sine Wave Output.....	4-28
Adjusting the Phase	4-29
Entering a Phase Angle	4-30
Entering a Power Factor	4-31
Editing and Error Output Settings.....	4-31
Editing the Output Setting.....	4-32
Displaying the UUT Error: AC and DC Voltage and Current Output.....	4-32
Displaying the UUT Error: Resistance Output.....	4-33
Using Multiply and Divide.....	4-33
Setting Voltage and Current Limits	4-33

Introduction

Warning

The 5080A Calibrator is capable of supplying lethal voltages. To avoid shock hazard, do not make connections to the output terminals when any voltage is present. Placing the instrument in standby may not be enough to avoid shock hazard, since the  key could be pressed accidentally. Press the  key and verify that the 5080A Calibrator is in standby before making connections to the output terminals.

This chapter presents instructions for operating the 5080A Calibrator from the front panel. For a description of front-panel controls, displays, and terminals, see Chapter 3, “Features.”

Turning on the Calibrator

Warning

To avoid electric shock, make sure the 5080A Calibrator is safely grounded as described in Chapter 2.

Caution

Before turning the 5080A Calibrator on, make sure that the line voltage selection is set properly. Refer to “Selecting Line Voltage” in Chapter 2 to check the line voltage setting.

When the 5080A Calibrator is powered, the initial display is “Starting Up...” (see below) and it completes a self-test routine. If a self-test fails, the Control Display identifies an error code. For a description of error codes, see Chapter 7, “Maintenance.”

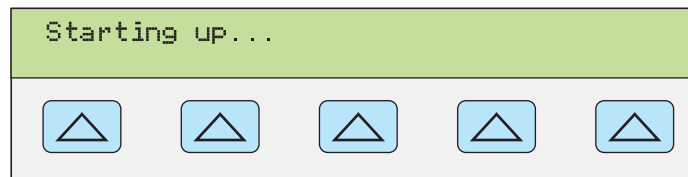

nn062f.eps

After self-test, the control display shows the reset condition (below).

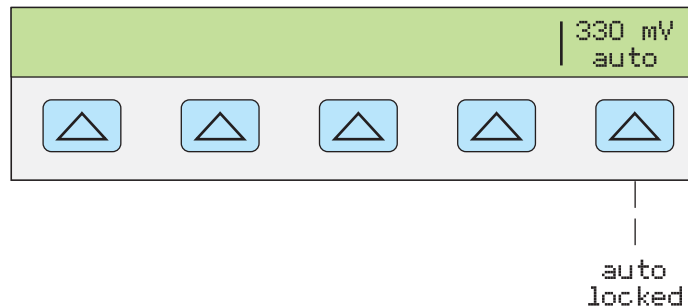

nn063f.eps

For a discussion of the softkey selection shown above (auto/locked), see “Auto Range Versus Locked Range” later in this chapter.

Warming up the Calibrator

When you turn on the 5080A, allow a warm-up period of at least 30 minutes for the

internal components to stabilize. This ensures that the calibrator meets or exceeds the specifications listed in Chapter 1.

If you turn the 5080A Calibrator off after warm-up and then on again, allow a warm-up period of at least twice the length of time it was turned off (maximum of 30 minutes). For example, if the calibrator is turned off for 10 minutes and then on again, allow a warm-up period of at least 20 minutes.

Using the Softkeys

The five keys just to the right of the **PREV MENU** (Previous Menu) key are called softkeys. Softkey key functions are based on the label that appears directly above the key in the Control Display. Pressing a softkey either changes a value or causes a submenu with new selections to appear on the Control Display. Softkey menus are arranged in varying levels, as described in “Softkey Menu Tree” in Chapter 3. You can move backwards to previous menu selections by repeatedly pressing **PREV MENU**. Although pressing **RESET** will also return you to the top level menu, it will also reset all volatile settings and return the 5080A Calibrator to 0 V dc in the standby mode. Use the **PREV MENU** key as your main navigating tool for moving around the menu levels.

Using the Setup Menu

Press the front-panel **SETUP** key for access to various operations and changeable parameters. Most parameters are nonvolatile, meaning they will be saved during reset or when power is turned off. Chapter 3 shows a map of the menu tree, lists the parameters, and has a table of factory default settings.

When you press **SETUP** from the power-up state, the display changes as follows:

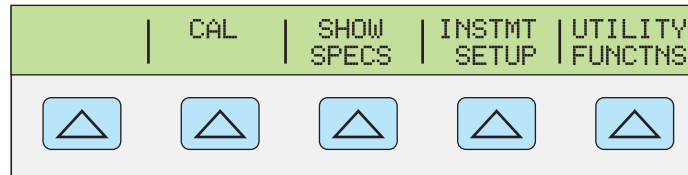

gew064f.eps

This is the primary instrument setup menu. The list below describes submenus available through each softkey and tells you where you can find further information in the manuals.

- **CAL (Calibration)** Opens the calibration menu. You use softkeys in this menu to view the calibration dates, print a calibration report, and perform 5080A calibration, and to run the Zero calibration routine. Zero calibration is described later in this chapter.
- **SHOW SPECS (Show Specifications)** Displays published 5080A Calibrator specifications for the output value that is currently selected.
- **INSTMT SETUP (Instrument Setup)** Lets you change the power-up or reset default setting for various instrument parameters. Many of the same parameters in this menu can be changed during operation, but the changes you make during operation are volatile. Changing them here makes them nonvolatile. To restore factory defaults, use the Format NV Memory menu under the UTILITY FUNCTNS menu.

- UTILITY FUNCTNS (Utility Functions) Allows you to initiate self-tests, format the nonvolatile memory (restore factory default settings), and review the instrument configuration software versions and user report string. These features are explained under “Utilities Function Menu” later in this chapter.

Using the Instrument Setup Menu

The softkeys in the instrument setup menu (accessed by pressing INSTMT SETUP softkey in the Setup Menu) are shown below.



nn065f.eps

The list below describes submenus accessed by each softkey.

- OTHER SETUP Opens a menu that lets you set the clock, and displayed error units.
- OUTPUT SETUP Opens a menu to change the power-up and reset defaults for current and voltage output limits and impedance for dBm display.
- DISPLAY SETUP Opens submenus to set the brightness and contrast of both the Control Display and Output Display and select the displayed front-panel language.
- REMOTE SETUP Allows you to change the configuration of the RS-232 port or Ethernet port. (See Chapter 5, “Remote Operation” for more information.)

Utility Functions Menu

The Setup Menu softkey labeled UTILITY FUNCTNS (Utility Functions) provides access to Self Test, Format Nonvolatile Memory, and Instrument Configuration.



nn066f.eps

- SELF TEST This softkey opens a menu with calibrator self-test choices.
- FORMAT NV MEM (Format Nonvolatile Memory) Opens a menu to restore all or part of the data in the nonvolatile memory to factory defaults.
- INSTMT CONFIG (Instrument Configuration) Allows you to view the versions of software installed in the calibrator as well as the user-entered report string.

Using the Format NV Memory Menu

⚠ Caution

Use with extreme care. The format nonvolatile memory menu softkeys permanently erase calibration constants. Pressing ALL or CAL invalidates the state of calibration of the 5080A.

Pressing FORMAT NV MEM in the utility functions menu opens the following:

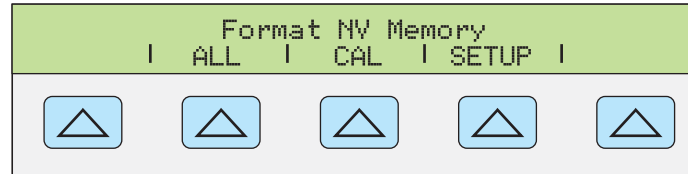

nn067f.eps

All the softkeys in this menu require the rear-panel CALIBRATION switch to be in the ENABLE position. The nonvolatile memory contains calibration constants and dates, setup parameters, and the user report string. In the case of calibration constants, factory defaults are the same for all Calibrators. They are not the calibration constants obtained when the 5080A was calibrated by the factory before shipment. The softkeys are:

- ALL replaces the entire contents of the NV memory with factory defaults. This would be used by service personnel after replacing the NV flash memory, for example. It is not required in normal use.
- CAL replaces all calibration constants with factory defaults but leaves all the setup parameters unchanged. This is also not required in normal use.
- SETUP replaces the setup parameters with factory defaults (Table 3-3) but leaves the state of calibration unchanged. You do not have to break the calibration sticker for this operation. Remote commands can also change the setup parameters. (See these commands in Chapter 6: SRQSTR, SPLSTR, *PUD, SP_SET, LIMIT.)

Resetting the Calibrator

At any time during front-panel operation (not remote operation), you can return the 5080A Calibrator to the power-up state by pressing **RESET**, except after an error message, which is cleared by pressing a blue softkey. Pressing the **RESET** key does the following:

- Returns the calibrator to the power-up state: 0 V dc, standby, 330 mV range and all OUTPUT SETUP menus set to their most recent default values.
- Clears the stored values for limits and error mode reference.

Zeroing the Calibrator

Zeroing recalibrates internal circuitry, most notably dc offsets in all ranges of operation. To meet the specifications in Chapter 1, zeroing is required every seven days, or when the 5080A Calibrator ambient temperature changes by more than 5 °C. The Calibrator displays a message when it is time to zero the calibrator. Zeroing is particularly important when your calibration workload has 1 mV resolution, and when there has been a significant temperature change in the 5080A Calibrator work environment.

Complete the following procedure to zero the calibrator.

Note

The 5080A Calibrator rear-panel CALIBRATION switch does not have to be enabled for this procedure.

Turn on the Calibrator and allow a warm-up period of at least 30 minutes.

1. Press **RESET**.
2. Press **SETUP**. The setup menu opens (below).



gew064f.eps

3. Press the **CAL** softkey. The calibration information menu opens (below).

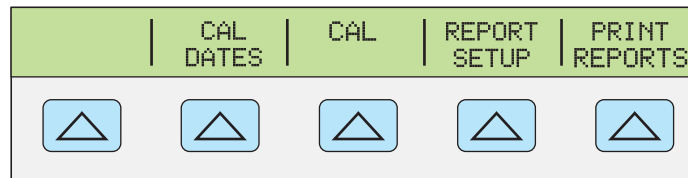

gew069f.eps

4. Press the **CAL** softkey. The calibration activity menu opens (below). **SCOPE CAL** appears as an option if it is installed.

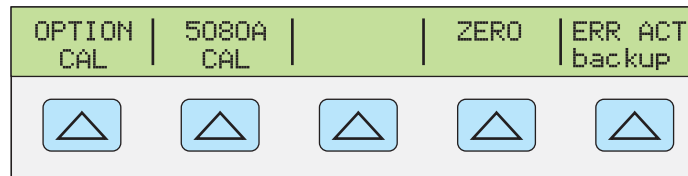

gew070f.eps

5. Press the **ZERO** softkey to totally zero the 5080A. After the zeroing routine is complete (several minutes), press **RESET** to reset the calibrator.

Using the Operate and Standby Modes

When the OPERATE annunciator is lit and **OPR** is displayed, the output value and function shown on the Output Display is active at the selected terminals. When **STBY** is displayed in the Output Display, all calibrator outputs are open-circuited. To enable the operate mode, press **OPR**. To place the calibrator in standby, press **STBY**.

If the calibrator is operating and any of the following events occur, the calibrator automatically goes into the standby mode:

- The **RESET** key is pressed.
- A voltage ≥ 33 V is selected when the previous output voltage was less than 33 V.
- Output function is changed between ac or dc voltage when the output voltage is ≥ 33 V; ac or dc current; resistance and any other function.
- The output location for current is changed from AUX to 20 A, or vice versa.
- An overload condition is detected.

Connecting the Calibrator to a UUT

Warning

The 5080A Calibrator is capable of supplying lethal voltages. Do not make connections to the output terminals when a voltage is present. Placing the instrument in standby may not be enough to avoid shock hazard, since the  key could be pressed accidentally. Press reset and verify that the STBY annunciator appears on the Control Display before making connections to the output terminals.

The outputs labeled NORMAL (HI and LO) are used to source voltage and resistance outputs. The LO terminal connects to the analog signal ground inside the guard shield. This signal line may or may not be tied to the guard shield and/or to chassis ground, depending on the settings of the  key. See “When to Use EARTH” on the next page for an explanation of these internal connections.

The outputs labeled AUX (HI and LO) source current and low voltage in the dual voltage function. These outputs are also used for four-wire or remote sensing in the resistance function.

When an oscilloscope calibration option is installed, the BNC connectors labeled SCOPE OUT and TRIG deliver signals for oscilloscope calibration.

Recommended Cable and Connector Types

Warning



Using standard banana plugs on the calibrator output will expose lethal voltages when not completely inserted into a mating terminal.

To avoid electric shock, use only cables with correct voltage ratings.

Cables to the calibrator are connected to the NORMAL and AUX terminals. To avoid errors induced by thermal voltages (thermal EMFs), use connectors and conductors made of copper or materials that generate small thermal EMFs when joined to copper. Avoid using nickel-plated connectors. Optimum results can be obtained by using Fluke Model 5440A-7002 Low Thermal EMF Test Leads, which are constructed of well-insulated copper wire and tellurium copper connectors. See the Accessories and Options section in Chapter 1.

When to Use EARTH

The 5080A Calibrator front-panel NORMAL LO terminal is normally isolated from earth (chassis) ground. When it is desired to make a connection between the NORMAL LO terminal and earth ground, press the  key, lighting the key annunciator.

To avoid ground loops and noise you must have only one earth ground-to-LO terminal connection in the system. Usually you make all signal ground connections at the UUT and verify the  annunciator is off. Generally,  is on only for ac and dc volts where the UUT is isolated from earth ground. There must, however, be a safety ground for the 5080A. See “Connecting to Line Power” in Chapter 2. When enabled by the sourced output, a softkey LOs appears, which allows you to tie or open an internal connection between the NORMAL LO terminal and AUX LO terminal. When tied and  is on, then both LO terminals are tied to chassis ground.

Four-Wire versus Two-Wire Connections

Four-wire and two-wire connections refer to methods of connecting the 5080A to the UUT to cancel out test lead resistance to assure the highest precision of the calibration output. Figures 4-2 through 4-3 illustrate the connection configurations for resistance; Part of the setting up the calibrator output for resistance includes selections for four-wire compensation (COMP 4-wire), two-wire compensation (COMP 2-wire) and two-wire no compensation (COMP off). (See “Setting Resistance Output” later in this chapter.)

Four-Wire Connection – The four-wire connection is typical for calibrating laboratory measurement equipment. Increased precision is provided for resistance values at or below 190 k Ω . For other values, the lead resistances do not degrade the calibration and the Calibrator changes the compensation to off (COMP off).

Two-Wire Compensation – The two-wire connection is typical for calibrating precision handheld Digital Multimeters (DMMs) with a two-wire input. Increased precision is provided for resistance values at or below 190 k Ω . For other values, the Calibrator changes the compensation to off (COMP off).

Compensation Off – Compensation off is a typical connection for calibrating handheld analog meters or DMMs with a two-wire input. This connection is used for all values of resistance and is usually selected when the analog meter or DMM level of accuracy does not require the additional precision. This is the default condition whenever an ohms output is made, following an output that was not ohms.

Cable Connection Instructions

Table 4-1 indicates a figure reference for each type of connection between a UUT and the 5080A Calibrator, referencing Figures 4-1 through 4-5.

To connect the calibrator to a UUT, proceed as follows:

1. If the calibrator is turned on, press **RESET** to remove the output from the calibrator terminals.
2. Make the connections to the UUT by selecting the appropriate figure from Table 4-1.

Table 4-1. UUT Connections

5080A Output	Figure Reference
Resistance	4-1 Resistance – four-wire compensated 4-2 Resistance - two-wire compensated 4-3 Resistance - compensation off
DC Voltage	4-4 DC Voltage/AC Voltage
AC Voltage	4-4 DC Voltage/AC Voltage
DC Current	4-5 DC Current/AC Current
AC Current	4-5 DC Current/AC Current

Note: See the discussion under “Four-Wire versus Two-Wire Connections” above.

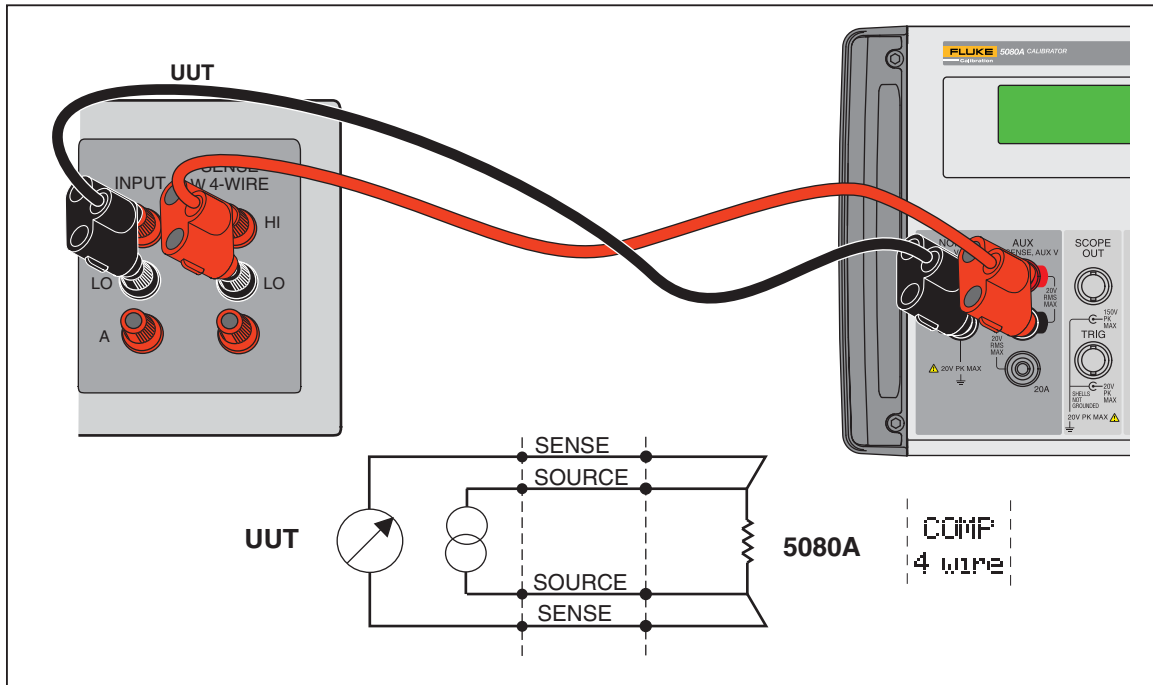

Figure 4-1. UUT Connection: Resistance (4-Wire Compensation)

gew040f.eps

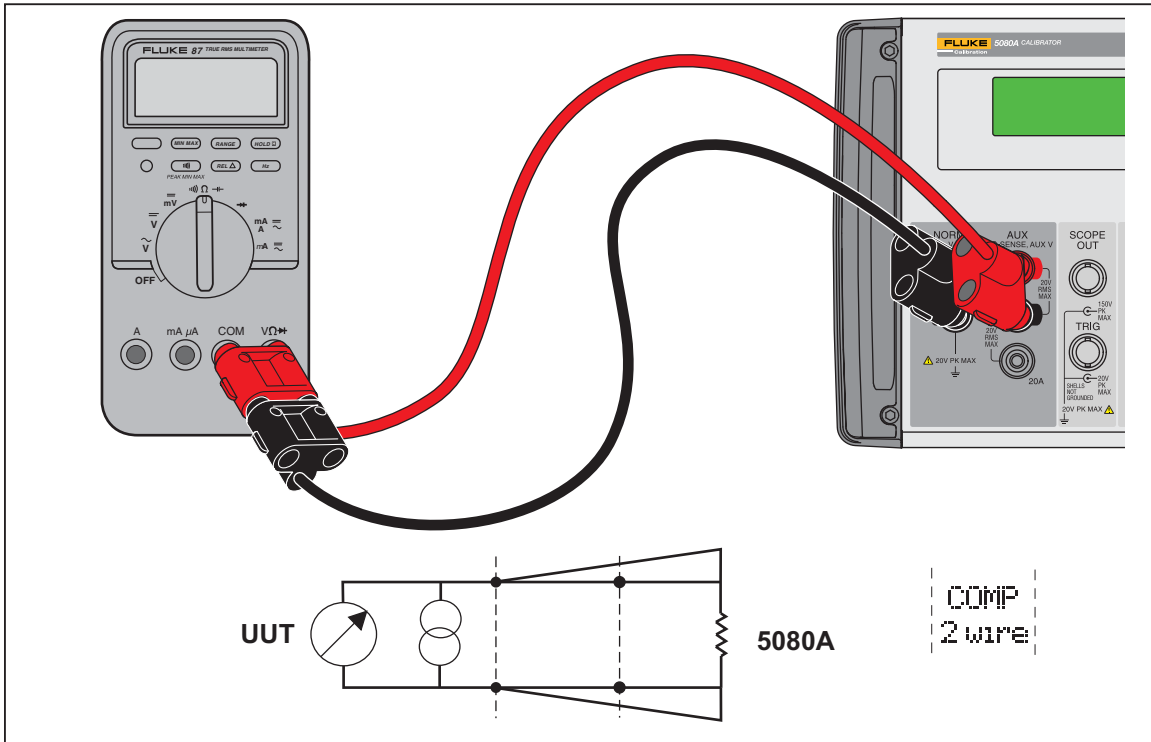

Figure 4-2. UUT Connection: Resistance (2-Wire Compensation)

gew041f.eps

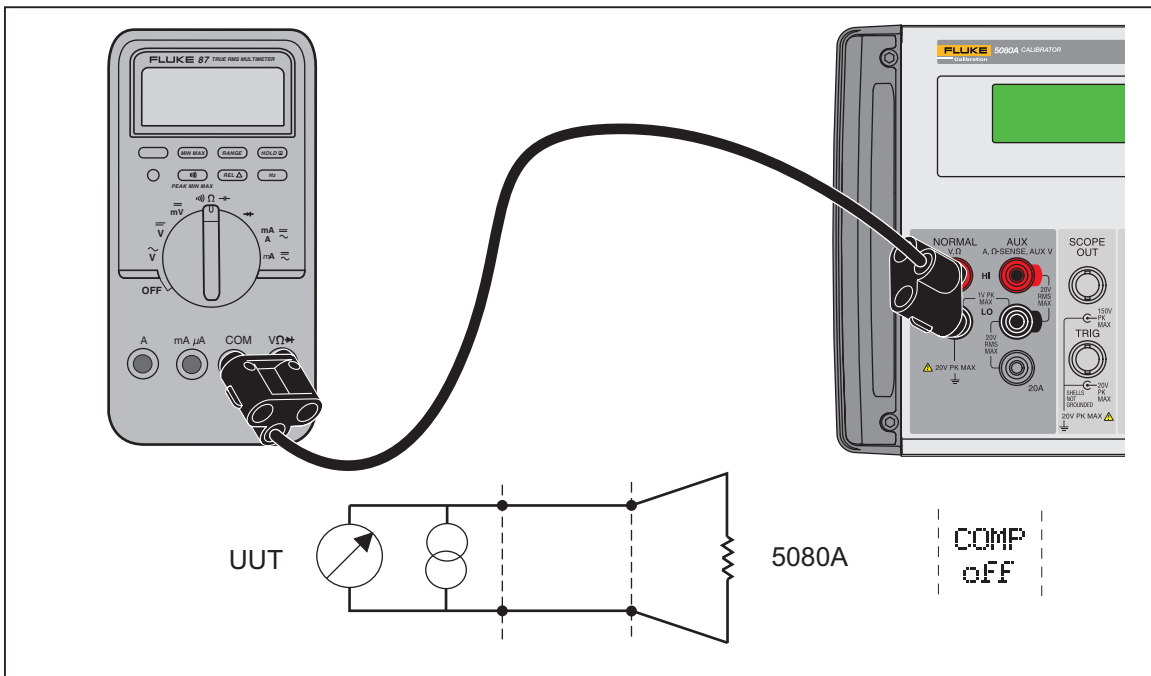

Figure 4-3. UUT Connection: Resistance (Compensation Off)

gew042f.eps

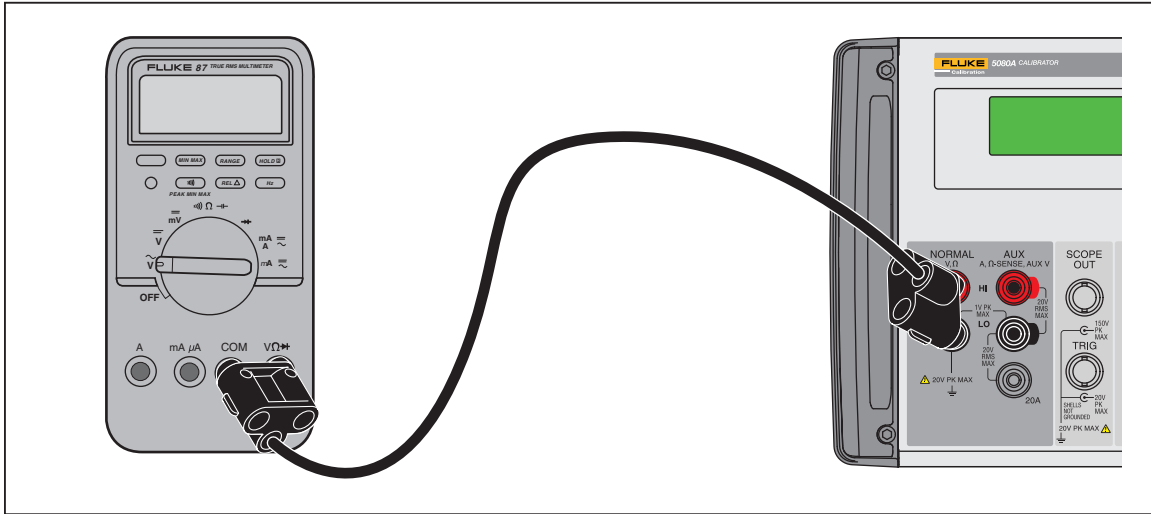

Figure 4-4. UUT Connection: DC Voltage/AC Voltage

gew046f.eps

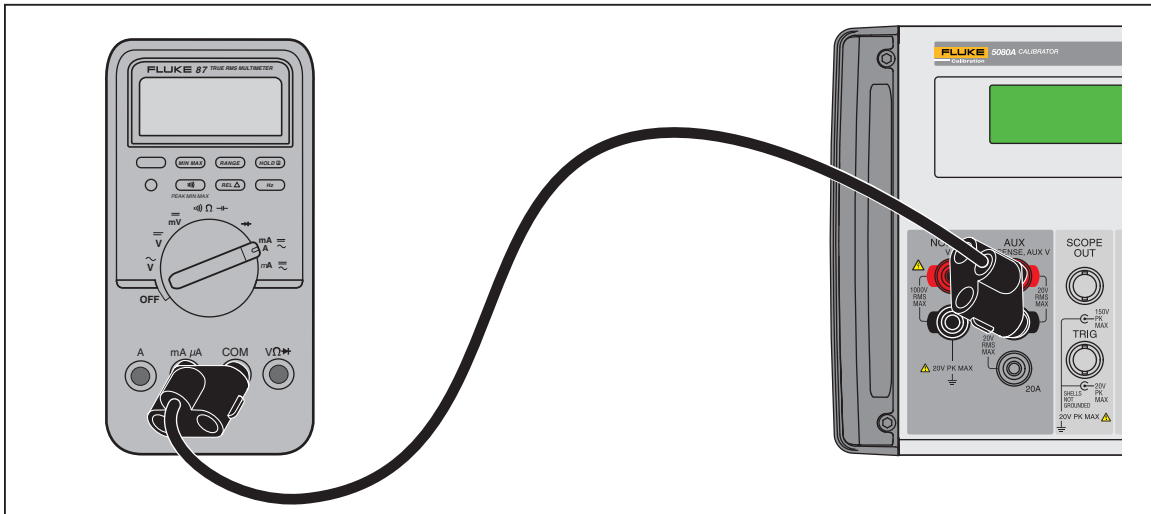
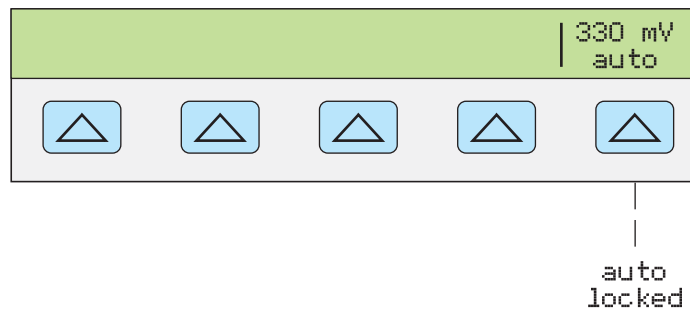

Figure 4-5. UUT Connection: DC Current/AC Current

gew047f.eps

Auto Range Versus Locked Range

A softkey is provided to toggle between the ranging method auto or locked. This feature is available only for single-output dc volts and dc current outputs.



nn063f.eps

When auto is selected (the default setting), the calibrator automatically selects the range

that provides the best output resolution. When locked is selected, the calibrator locks the selected range and will not change ranges when you are editing the output, or entering new outputs. Values lower or higher than the locked range are not allowed. The locked selection is usually made when you do not want range changes that may cause a small perturbation in the output, e.g., when checking the linearity of a given multimeter range.

Setting the Output

Setting the calibrator output is similar to entering values into a calculator: press the keys that represent the value you desire and then press a units key to identify which of the volts, amps, hertz, etc., you want the value to represent. The control display indicates the value and units you select as you type them into the calibrator. Once you are satisfied with the value and units, press **ENTER**. If the output display indicates **STBY**, press **OPR** to output the selection. The display of a small “u” (unsettled) in the Output Display indicates the calibrator is allowing for its internal circuitry to settle.

For example, to set the output to 10 V dc, press:

1 → 0 → ^{DC}V → ENTER → **OPR**

To set the output to 20 V ac at 60 Hz, press:

2 → 0 → ^{AC}V → 6 → 0 → ^{Hz} → ENTER → **OPR**

To change the output to dc, press:

0 → ^{Hz} → ENTER or +/- → ENTER

Step-by-step procedures are provided for each output function as follows:

- dc voltage
- ac voltage
- dc current
- ac current
- dc power
- ac power
- dual dc voltage
- dual ac voltage
- resistance

Setting DC Voltage Output

Complete the following procedure to set a dc voltage output at the 5080A front-panel NORMAL terminals. If you make an entry error, press **CE** to clear the display, then reenter the value.

⚠ Caution

To avoid damage to the UUT, verify the applied voltage to the UUT does not exceed the rating of the UUT insulation and the interconnecting wiring.

1. Press **RESET** to clear any output from the 5080A.
2. Connect the UUT as described earlier in this chapter under “Connecting the Calibrator to a UUT.”
3. Set the UUT to measure dc voltage on the desired range.
4. Press the numeric keys and decimal point key to enter the desired voltage output

(maximum six numeric keys). For example, 123.456.

Note

At voltage outputs of 100 V and above (nominal), you may notice a slight high-pitched sound. This is normal.

5. Press $\boxed{+/-}$ to select the polarity of the voltage (default is +).
6. Press a multiplier key, if necessary. For example, press $\boxed{\mu m}$.
7. Press \boxed{V} .
8. The Control Display now shows the amplitude of your entry. For example, 123.456 mV (below).

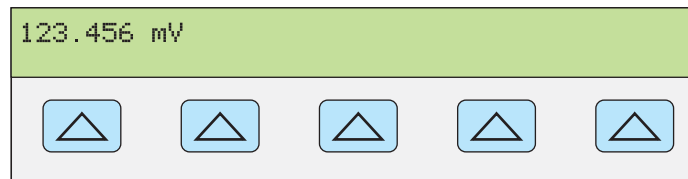

nn071f.eps

9. Press \boxed{ENTER} . The calibrator clears your entry from the Control Display and copies it into the Output Display (below is typical).

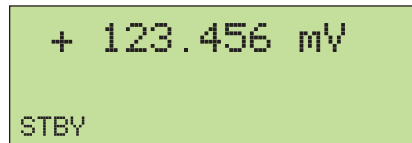

nn072f.eps

10. Press \boxed{OPR} to activate the calibrator output.

A softkey label for range appears on the Control Display in the dc voltage function:

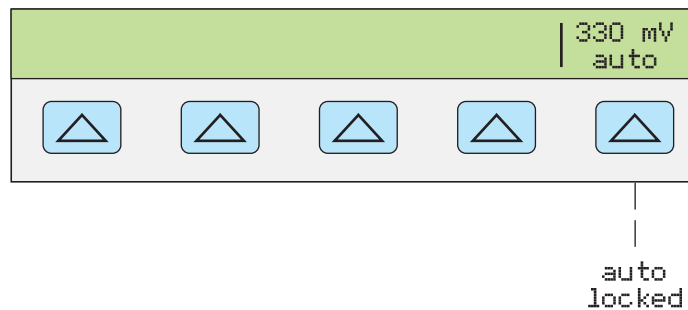

nn063f.eps

- Range (Operating Range) selects autorange (auto) or lock (locked) for the present range. When auto (the default setting) is selected, the calibrator automatically selects the range that provides the best output resolution. When locked is selected, the calibrator will not change ranges when you are editing the output. The locked selection is usually made when you do not want range changes that may cause a small perturbation in the output, e.g., when checking the linearity of a given multimeter range.

Setting AC Voltage Output

You may select an ac voltage output in volts or as a power output in dBm, where dBm is $10 \log(P_{out}/.001)$, where P_{out} is expressed in watts. The output range is 1 mV to 1020 V. When selecting dBm outputs, the 5080A calculates dBm at a selected impedance

level. Based on this, the formula is:

$$20 \log(V) - 10 \log(\text{Impedance} * .001) = \text{dBm}.$$

Complete the following procedure to set an ac voltage output at the 5080A front-panel NORMAL terminals. If you make an entry error, press **CE** to clear the display, then reenter the value.

⚠ Caution

To avoid damage to the UUT, verify the applied voltage to the UUT does not exceed the rating of the UUT insulation and the interconnecting wiring.

1. Press **RESET** to clear any output from the 5080A.
2. Connect the UUT as described earlier in this chapter under “Connecting the Calibrator to a UUT.”
3. Set the UUT to measure ac voltage on the desired range.
4. Output in volts Press the numeric keys and decimal point key to enter the desired voltage output (maximum five numeric keys). For example, 2.4494.

Output in dBm Press the numeric keys and decimal point key to enter the desired power output (maximum four numeric keys). For example, 10.00. For a power output less than 1 mW (negative dBm values), press **+/-** to append the numeric entry with the negative (–) symbol.

When you press the dBm key, the right most softkey becomes active. This allows the dBm value and output impedance to be entered as a unit.

When output is entered in dBm, the Control Display appears as follows:

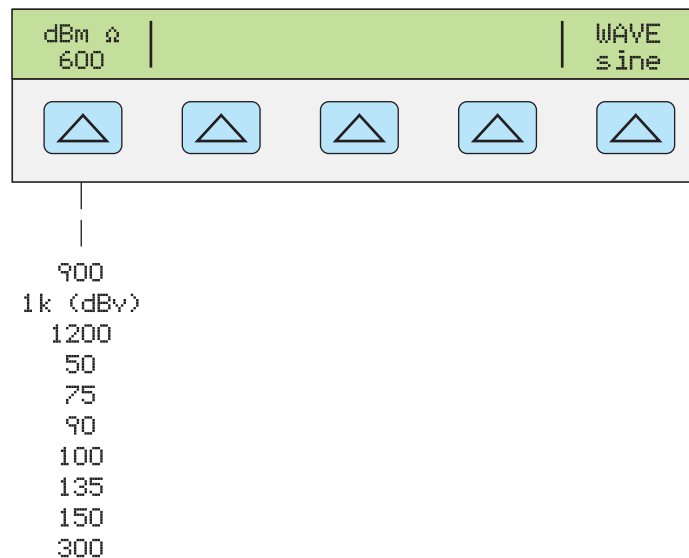

gew227f.eps

Note

At voltage outputs of 100 V and above (nominal), you may notice a slight high-pitched sound. This is normal.

5. Press a multiplier key, if necessary. For example, press **μm**.
6. Output in volts. Press **μV**.
Output in dBm. Press **SHIFT μV**. Select an impedance for dBm from a list on the

Control Display using the rightmost softkey.

7. The Control Display now shows the amplitude of your entry. For example, 2.4494 V (below).



nn073f.eps

8. Press the numeric keys and decimal point key to enter the desired frequency output (maximum five numeric keys). Press a multiplier key, if necessary. For example, press the kilo multiplier key \boxed{k} . Then press the \boxed{Hz} key. For example, 983.2 Hz (below).

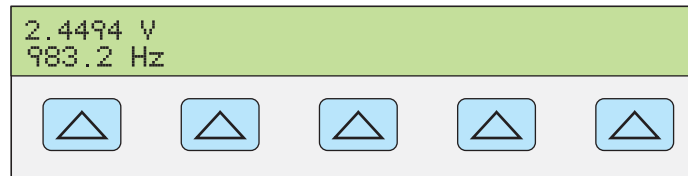

nn074f.eps

9. Press \boxed{ENTER} . The calibrator clears your entry from the Control Display and copies it into the Output Display (below is typical).

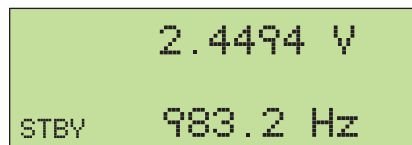

nn075f.eps

10. Press \boxed{OPR} to activate the calibrator output.

Setting DC Current Output

Complete the following procedure to set a dc current output between AUX HI and LO or AUX 20A and LO, depending on the current level selected. Current greater than ± 3 A is sourced between the AUX 20A and LO terminals. If you make an entry error, press \boxed{CE} to clear the display, then reenter the value.

1. Press \boxed{RESET} to clear any output from the calibrator.
2. Connect the UUT as described earlier in this chapter under "Connecting the Calibrator to a UUT."
3. Set the UUT to measure dc current on the desired range.
4. Press the numeric keys and decimal point key to enter the desired current output (maximum five numeric keys). For example, 234.56.
5. Press $\boxed{+/-}$ to select the polarity of the current (default is +).
6. Press a multiplier key, if necessary. For example, press \boxed{m} .
7. Press \boxed{A} .
8. The Control Display now shows the amplitude of your entry. For example, 234.56 mA.

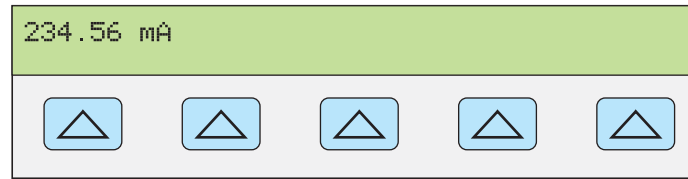

nn077f.eps

9. Press **ENTER**. The calibrator clears your entry from the Control Display and copies it into the Output Display (below is typical).

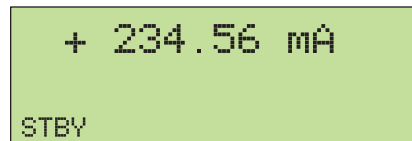

nn078f.eps

10. Press **OPR** to activate the calibrator output.

A range softkey appears on the Control Display in the dc current function (operating range). This selects autorange (auto) or lock (locked) for the present range. When auto (the default setting) is selected, the calibrator automatically selects the range that provides the best output resolution. When locked is selected, the calibrator will not change ranges when you are editing the output. The locked selection is usually made when you do not want range changes that may cause a small perturbation in the output, for example, when checking the linearity of a given multimeter range.

Another softkey appears: **OUTPUT**. When you select 20 A for this parameter, or you select a current above 3 A, the calibrator switches to standby, and you must change the test lead to the 20A terminal and press **OPR** to activate the output.

Setting AC Current Output

Complete the following procedure to set an ac current output at the AUX or 20A terminals. If you make an entry error, press **CE** to clear the display, then reenter the value.

1. Press **RESET** to clear any output from the 5080A.
2. Connect the UUT as described earlier in this chapter under “Connecting the Calibrator to a UUT.”
3. Set the UUT to measure ac current on the desired range.
4. Press the numeric keys and decimal point key to enter the desired current output (maximum five numeric keys). For example, 123.45.
5. Press a multiplier key, if necessary. For example, press **m**.
6. Press **A**.
7. The Control Display now shows the amplitude of your entry. For example, 123.45 mA (below).

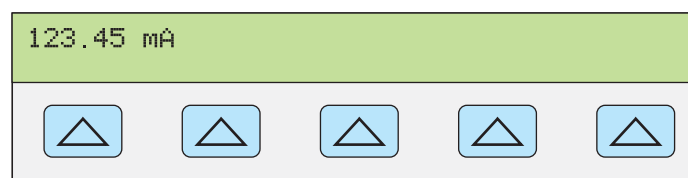

nn079f.eps

8. Press the numeric keys and decimal point key to enter the desired frequency output

(maximum five numeric keys). Then press the $\boxed{\text{Hz}}$ key. For example, 983.2 Hz (below).



nn080f.eps

9. Press $\boxed{\text{ENTER}}$. The calibrator clears your entry from the Control Display and copies it into the Output Display (below is typical).



nn081f.eps

10. Press $\boxed{\text{OPR}}$ to activate the calibrator output.

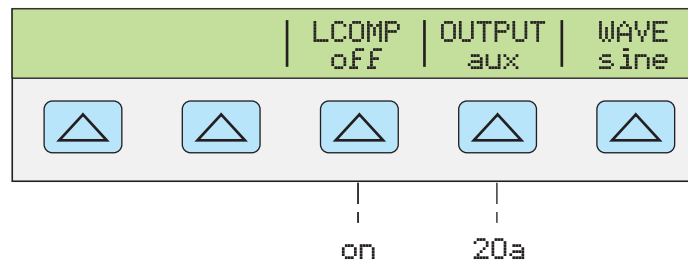

gew321f.eps

- LCOMP turns inductive compensation on and off. Inductive compensation is available for frequencies up to 65 Hz. LCOMP also enables higher compliance voltages in 33 mA and 330 mA ranges when “on”. See specifications for voltage limits.
- OUTPUT shows whether the output is on the AUX or 20A terminals. Outputs 3 A or above are always on the 20A terminals.
- WAVE (waveform) always shows the output signal as a sine wave.

Setting DC Power Output

Note

Tie the terminals NORMAL LO and AUX LO together at the UUT or at the 5080A, via the “LO”s softkey selection “tied.”

The calibrator produces a dc power output by sourcing a dc voltage on the NORMAL outputs and a dc current on the AUX outputs. Complete the following procedure to set a dc power output. If you make an entry error, press $\boxed{\text{CE}}$ one or more times to clear the display, then reenter the value.

⚠ Caution

To avoid damage to the UUT, verify the applied voltage to the UUT does not exceed the rating of the UUT insulation and the interconnecting wiring.

1. Press $\boxed{\text{RESET}}$ to clear any output from the 5080A.

2. Connect the UUT as described earlier in this chapter under “Connecting the Calibrator to a UUT” by adapting the voltage and current connections.
3. Set the UUT to measure dc power on the desired range.
4. Press the numeric keys and decimal point key to enter the desired voltage output (maximum five numeric keys). For example, 123.45.

Note

At voltage outputs of 100 V and above (nominal), you may notice a slight high-pitched sound. This is normal.

5. Press $\boxed{+/-}$ to select the polarity of the voltage (default is +).
6. Press a multiplier key, if necessary. For example, press $\boxed{\mu m}$.
7. Press \boxed{V} .

The Control Display now shows the amplitude of your entry. For example, 123.456 mV (below).

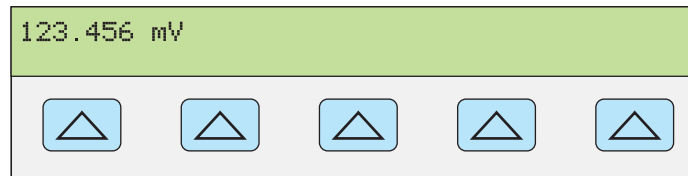

nn071f.eps

8. Press the numeric keys and decimal point key to enter the desired current output (maximum five numeric keys). For example, 234.56.
9. Press $\boxed{+/-}$ to select the polarity of the current (default is +).
10. Press a multiplier key, if necessary. For example, press $\boxed{\mu m}$.
11. Press \boxed{A} .

The Control Display now shows the amplitude of your entries. For example, 123.456 mV and 234.56 mA (below).

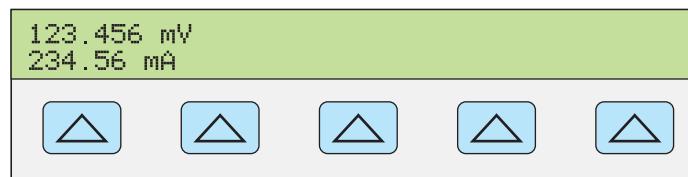

nn082f.eps

12. Press \boxed{ENTER} . The calibrator clears your entry from the Control Display and copies it into the Output Display (below is typical).

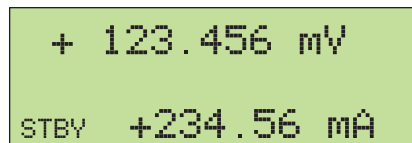

nn083f.eps

13. Press \boxed{OPR} to activate the calibrator output. When changing power output levels, you must reenter both voltage and current (in either order).

(Enter voltage or current and then a watts entry value using $\boxed{SHIFT} \boxed{A}$. The remaining volts or current value is calculated and displayed.)

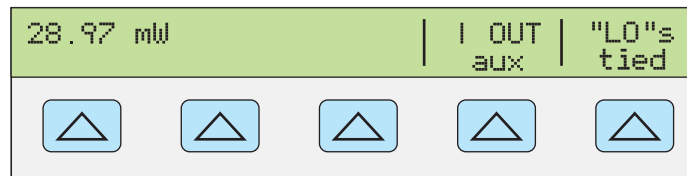

mn322f.eps

- I OUT selects AUX or 20A terminals. Current outputs 3 A or above are always on the 20A terminals.
- “LO”s ties or opens a connection between front-panel NORMAL LO and AUX LO terminals. The front-panel NORMAL LO and AUX LO terminals must be tied together either at the UUT or at the 5080A. The default is tied.

Setting AC Power Output

Note

Tie the terminals NORMAL LO and AUX LO together at the UUT, or at the 5080A via the “LO”s softkey selection “tied.” For optimum phase performance, tie the LO terminals at the UUT. At current levels > 2.2 A, tie the terminals at the UUT using heavy gauge wire < 10 mΩ resistance.

The calibrator produces an ac power output by sourcing an ac voltage on the NORMAL outputs and an ac current on the AUX outputs.

See “Setting AC Voltage Output” above for information on selecting an ac voltage output in dBm; this procedure assumes an ac voltage output in volts.

Complete the following procedure to set an ac power output. If you make an entry error, press **[CE]** one or more times to clear the display, then reenter the value.

⚠ Caution

To avoid damage to the UUT, verify the applied voltage to the UUT does not exceed the rating of the UUT insulation and the interconnecting wiring.

1. Press **[RESET]** to clear any output from the 5080A.
2. Connect the UUT as described earlier in this chapter under “Connecting the Calibrator to a UUT.” (Adapt the voltage and current connections to suit your application.)
3. Set the UUT to measure ac power on the desired range.
4. Press the numeric keys and decimal point key to enter the desired voltage output (maximum five numeric keys). For example, 123.45.

Note

At voltage outputs of 100 V and above (nominal), you may notice a slight high-pitched sound. This is normal.

5. Press a multiplier key, if necessary. For example, press **[m]**.
6. Press **[V]**.
7. The Control Display now shows the amplitude of your voltage entry. For example, 123.45 mV (below).



nn084f.eps

8. Press the numeric keys and decimal point key to enter the desired current output (maximum five numeric keys). For example, 234.56.
9. Press a multiplier key, if necessary. For example, press μm .
10. Press mA .
11. The Control Display now shows the amplitude of your voltage and current entries. For example, 123.45 mV and 234.56 mA (below).

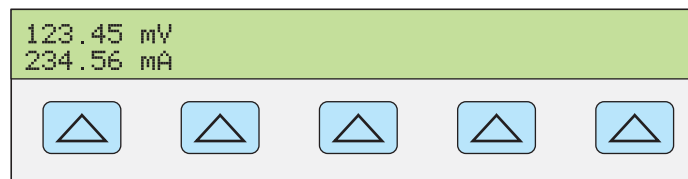

nn085f.eps

12. Press the numeric keys and decimal point key to enter the desired frequency output (maximum five numeric keys). Then press the Hz key. For example, 983.2 Hz.
13. The Control Display now shows your entries. For example, 123.45 mV and 234.56 mA at 983.2 Hz (below).

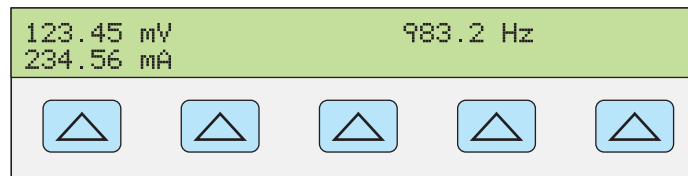

nn086f.eps

14. Press ENTER . The calibrator clears your entry from the Control Display and copies it into the Output Display (below is typical).

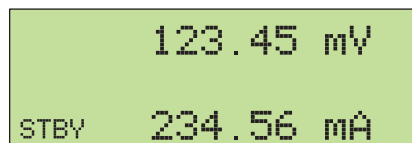

nn087f.eps

15. Press OPR to activate the calibrator output. When changing power output levels, you must reenter both voltage and current (in either order).

(Enter voltage or current and then a watts entry value using $\text{SHIFT } \text{mA}$. The remaining volts or current value is calculated and displayed.)

Three softkey labels appear on the Control Display: WAVE MENUS, I OUT (AUX or 20A terminals), and LCOMP (off or on). The Control Display also shows the real power output for sine waves. Power out is computed as $\text{Power} = \text{Cosine } \Phi (\text{Volts} \times \text{Current})$ where Φ is the phase difference between the volts and current waveforms. $\text{Cosine } \Phi$ is also known as the Power Factor (PF).

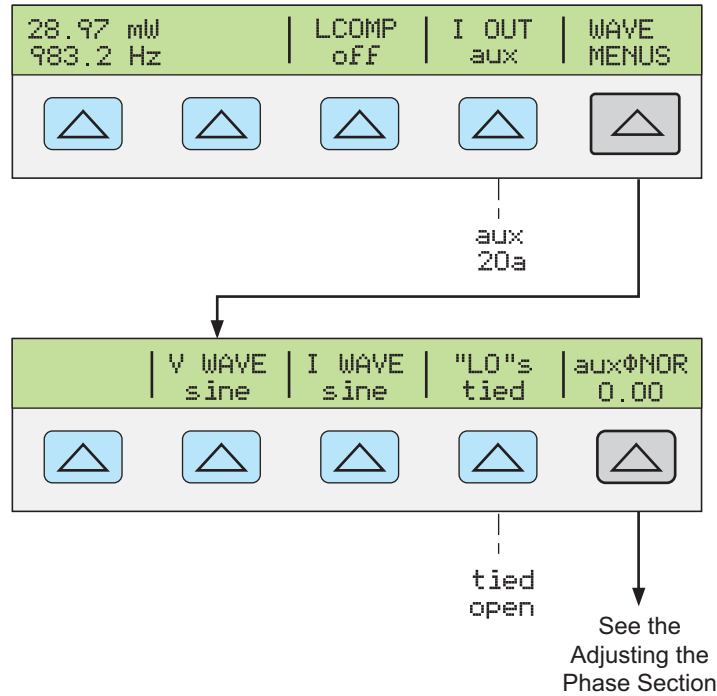

nn088f.eps

Setting a Dual DC Voltage Output

Note

Tie the terminals NORMAL LO and AUX LO together at the UUT or at the 5080A, via the “LO”s softkey selection “tied.”

The calibrator produces a dual dc voltage output by sourcing one dc voltage on the NORMAL outputs and a second on the AUX terminals. Complete the following procedure to set a dual dc voltage output. If you make an entry error, press **CE** one or more times to clear the display, then reenter the value.

⚠ Caution

To avoid damage to the UUT, verify the applied voltage to the UUT does not exceed the rating of the UUT insulation and the interconnecting wiring.

1. Press **RESET** to clear any output from the 5080A.
2. Connect the UUT as described earlier in this chapter under “Connecting the Calibrator to a UUT.”
3. Set the UUT to measure dual dc voltage on the desired range.
4. Press the numeric keys and decimal point key to enter the desired voltage output at the NORMAL terminals (maximum six numeric keys). For example, 123.456.
5. Press **+/-** to select the polarity of the voltage (default is +).
6. Press a multiplier key, if necessary. For example, press **μm**.
7. Press **V^{DC}**.
8. The Control Display now shows the amplitude of your entry for the NORMAL terminals. For example, 123.456 mV (below).

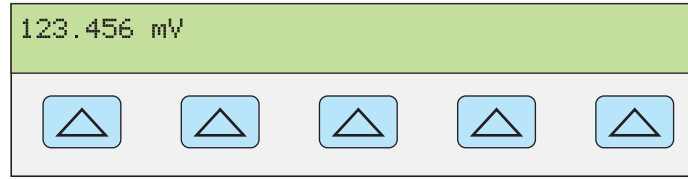

nn071f.eps

Note

Voltage on the AUX output is limited to 7.000 V maximum.

9. Press the numeric keys and decimal point key to enter the desired voltage output at the AUX terminals (maximum five numeric keys). For example, 234.56.
10. Press $\boxed{+/-}$ to select the polarity of the voltage (default is +).
11. Press a multiplier key, if necessary. For example, press \boxed{m} .
12. Press \boxed{V} .
13. The Control Display now shows the amplitude of your entries for the NORMAL terminals (upper reading) and AUX terminals (lower reading) (see below).

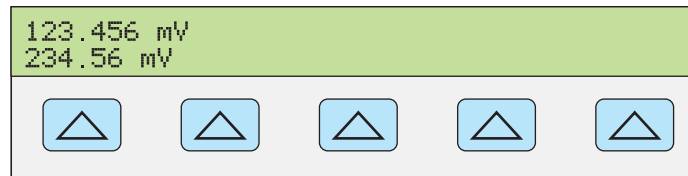

gew358.eps

14. Press \boxed{ENTER} . The calibrator clears your entry from the Control Display and copies it into the Output Display (below is typical).

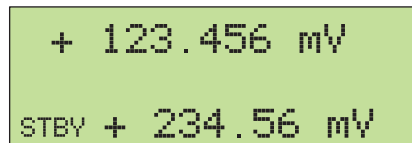

gew366.eps

15. Press \boxed{OPR} to activate the calibrator output.

A softkey labeled "LO"s appears on the Control Display.

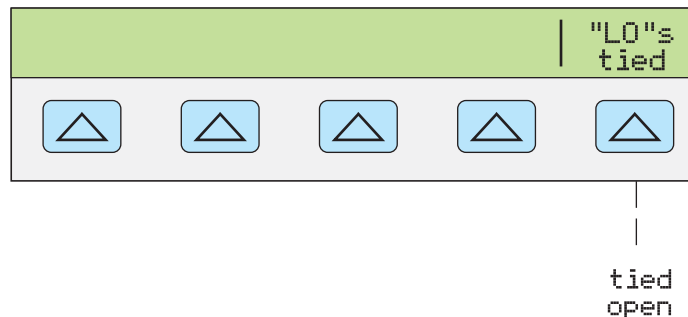

gew360.eps

- "LO"s (Low Potential Output Terminals) The front-panel NORMAL LO and AUX LO terminals must be tied together either at the UUT or at the 5080A. When the front-panel NORMAL LO and AUX LO terminals are tied at the UUT, select "open" with the "LO"s softkey. If the NORMAL LO and AUX LO terminals are not tied at the UUT, select "tied" with the "LO"s softkey. The default is tied.

Setting a Dual AC Voltage Output

Note

Tie the terminals NORMAL LO and AUX LO together at the UUT or at the 5080A, via the “LO”s softkey selection “tied.”

The calibrator produces a dual ac voltage output by sourcing one ac voltage on the NORMAL outputs and a second on the AUX terminals.

Complete the following procedure to set a dual ac voltage output. If you make an entry error, press **CE** one or more times to clear the display, then reenter the value.

⚠ Caution

To avoid damage to the UUT, verify the applied voltage to the UUT does not exceed the rating of the UUT insulation and the interconnecting wiring.

1. Press **RESET** to clear any output from the 5080A.
2. Connect the UUT as described earlier in this chapter under “Connecting the Calibrator to a UUT.”
3. Set the UUT to measure dual ac voltage on the desired range.
4. Press the numeric keys and decimal point key to enter the desired voltage output at the NORMAL terminals (maximum five numeric keys). For example, 123.45.
5. Press a multiplier key, if necessary. For example, press **m**.
6. Press **V**.
7. The Control Display now shows the amplitude of your voltage entry. For example, 123.45 mV (below).

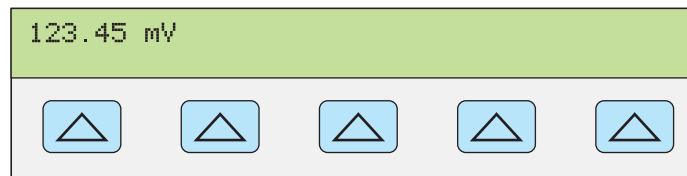

nn084f.eps

Note

The AUX output is limited to 5.000 V rms for sine waves.

8. Press the numeric keys and decimal point key to enter the desired voltage output at the AUX terminals (maximum five numeric keys). For example, 234.56.
9. Press a multiplier key, if necessary. For example, press **m**.
10. Press **V**.
11. The Control Display now shows the amplitude of your entries for the NORMAL terminals (upper reading) and AUX terminals (lower reading) (below is typical).

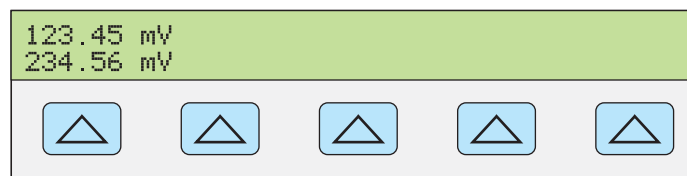

gew367.eps

12. Press the numeric keys and decimal point key to enter the desired frequency output

(maximum five numeric keys). Then press the **[Hz]** key. For example, 983.2 Hz.

13. The Control Display now shows your voltage and frequency entries. For example, 123.45 mV and 234.56 mV at 983.2 Hz (below).

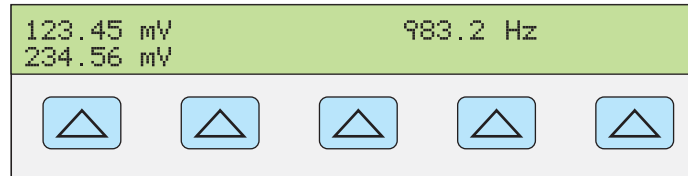

gew361.eps

14. Press **[ENTER]**. The calibrator clears your entry from the Control Display and copies it into the Output Display (below is typical).

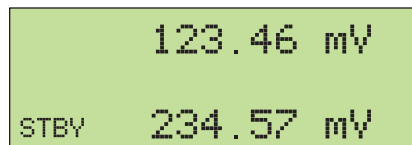

gew364.eps

15. Press **[OPR]** to activate the calibrator output.

Two softkey labels appear on the Control Display: V @ NOR, V @ AUX and WAVE MENUS.

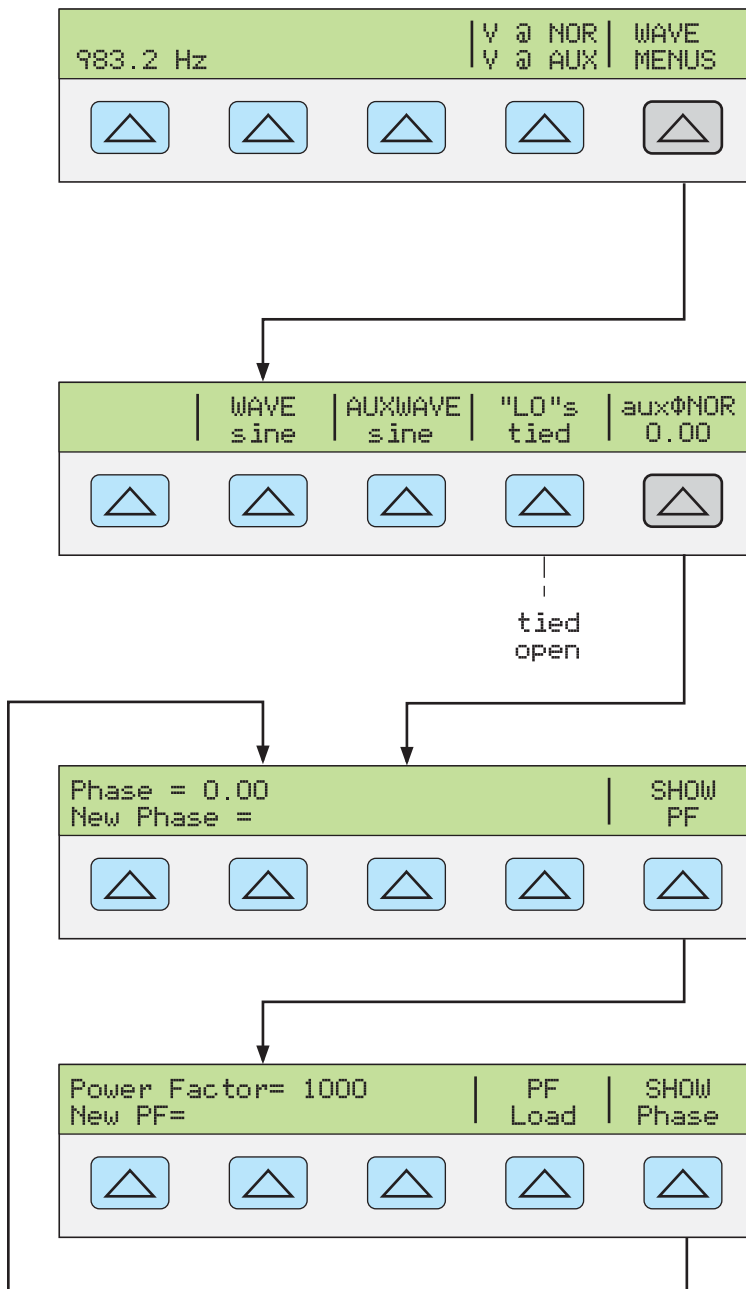

gew362.eps

- V @ NOR (Voltage at NORMAL Terminals) V @ AUX (Voltage at AUX Terminals) This is an information-only softkey position and does not have an associated function. It shows the output function is dual ac voltage.
- WAVE MENUS (Waveform Menus) Opens submenus for selecting the type of waveform, front-panel LO terminal condition, and phase.
 - WAVE (waveform) Always shows the output signal as a sine wave.
 - AUXWAVE (waveform) Always shows the output signal as a sine wave.
 - "LO"s (Low Potential Output Terminals) The front-panel NORMAL LO and AUX LO terminals must be tied together either at the UUT or at the 5080A. When the front-panel NORMAL LO and AUX LO terminals are tied at the UUT, select "open" with the "LO"s softkey. If the NORMAL LO and AUX LO

terminals are not tied at the UUT, select “tied” with the “LO”s softkey. The default is tied.

- auxφNOR (Phase Difference) Selects the phase difference between the NORMAL and AUX outputs. See “Adjusting the Phase” later in this chapter.

Setting Resistance Output

In the resistance function, the calibrator supplies your choice of 18 standard resistance values or a short at the output terminals. Table 4-2 lists the 18 standard resistance values available from the Calibrator.

Table 4-2. Standard Calibrator Resistances

Resistance Value	Resistance Value
1.0 Ω	19 kΩ
1.9 Ω	100 kΩ
10 Ω	190 kΩ
19 Ω	1.0 MΩ
100 Ω	1.9 MΩ
190 Ω	10 MΩ
1.0 kΩ	19 MΩ
1.9 kΩ	100 MΩ
10 kΩ	190 MΩ

To select a resistance output:

1. Make sure the calibrator is in standby. Press if necessary.
2. If the UUT is not connected, connect it now as described previously in this chapter under “Connecting the Calibrator to a □UUT.”
3. Set the UUT to read resistance on the appropriate range.
4. Press the numeric keys for one of the 18 resistances in Table 4-2. For example 1.9.
5. Press a multiplier key, if necessary. For example, press .
6. Press .
7. Press .
8. The Control Display now shows the value of your entry. For example, 1.9 kΩ (below).

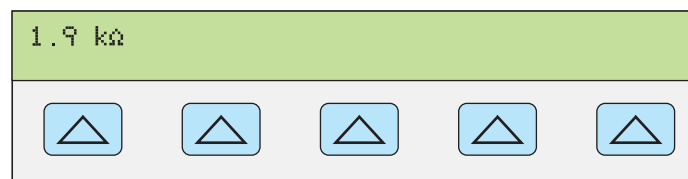

gew363.eps

Note

If you entered a resistance value that is unavailable, an error message is displayed.

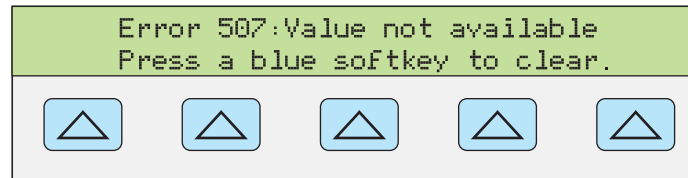

gew356.eps

9. After you specify a valid resistance and press **ENTER**, the calibrator clears your entry from the Control Display and shows the characterized (true) resistance value on the Output Display (below is typical).

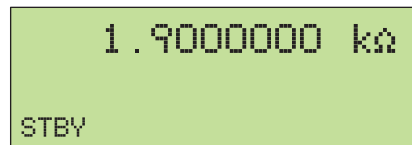

gew365.eps

10. Press **OPR** to activate the calibrator output.

The softkeys allow selection of three lead-compensation settings.

- The COMP (Compensation) softkey is only selectable for resistance values of 190 kΩ or lower. It turns on and off internal two-wire lead compensation circuitry or selects 4-wire compensation. See “Four-Wire versus Two-Wire Connections” earlier in this chapter for more information.

In the resistance function, two features are available to enhance accuracy: four-wire sensing and two-wire compensation. Two-wire compensation works with either a two-wire connection or a four-wire connection to a two-wire ohmmeter. A full explanation follows:

Four-wire connection is available for resistance values 190 kΩ or lower. To activate four-wire resistance, press COMP until 4-wire appears. (Figure 4-1 shows the four-wire connection.)

For calibrating a meter with a two-wire resistance mode such as a typical handheld DMM, refer to Figures 4-2 and 4-3. For resistances of 190 kΩ or lower in two-wire mode, compensation circuitry inside the calibrator is available to remove errors introduced by resistance in the path between the front-panel terminals and the precision resistor. This softkey allows you to disable and enable the compensation circuitry. To activate 2-wire resistance compensation, press COMP until 2-wire appears.

Depending on how you connect the meter, you can use two-wire compensation referenced at the UUT terminals (Figure 4-2).

Figure 4-3 shows a meter connected in a two-wire connection with the two-wire compensation circuitry turned off. Use this configuration only if lead resistances are insignificant. For a two-wire connection, press COMP until off appears..

For resistances where uncompensated lead resistances are significant, use the two-wire compensation circuit and the connection in Figure 4-2. Use the connection in Figure 4-1 if you want to calibrate the meter referenced at its terminals. Use the connection in Figure 4-3 if you want to calibrate the meter referenced at the ends of its test leads.

Sine Wave Output

The calibrator has a sine wave output for ac power or dual ac voltage (Figure 4-6). The variables for the sine wave are amplitude and frequency.

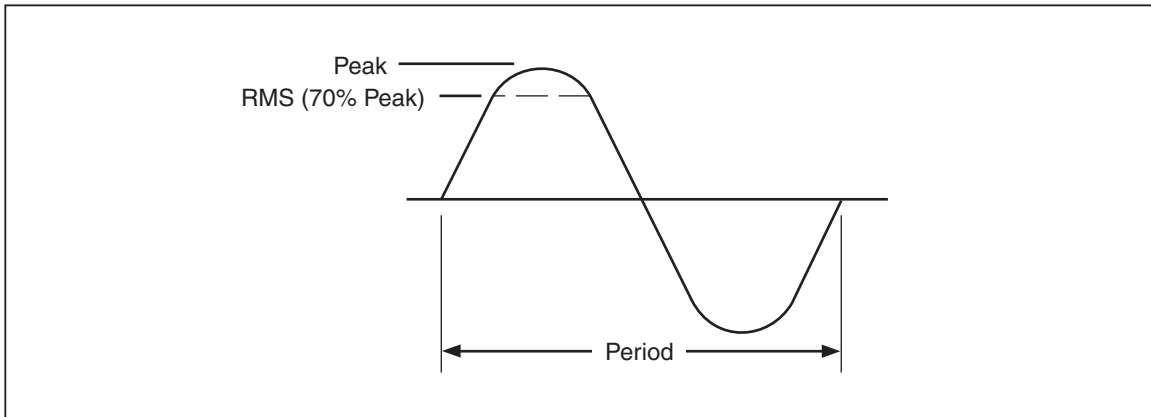

Figure 4-6. Sine Wave

nn026f.eps

Adjusting the Phase

When in the dual ac voltage and ac power output modes, you can set the calibrator to source two signals with adjustable phase difference. All phase adjustments shift the AUX waveform in relation to the NORMAL waveform. Phase shift adjustments are entered into the calibrator either as degrees (0 to ± 180.00) or as a power factor (PF). A leading or positive phase shift will cause the AUX waveform to lead the NORMAL waveform; a lagging or negative phase shift will cause the AUX waveform to lag the NORMAL waveform.

The softkey PHASE is available after pressing the WAVE MENUS softkey that appears when outputting dual ac voltages or ac power (shown below for ac power output).

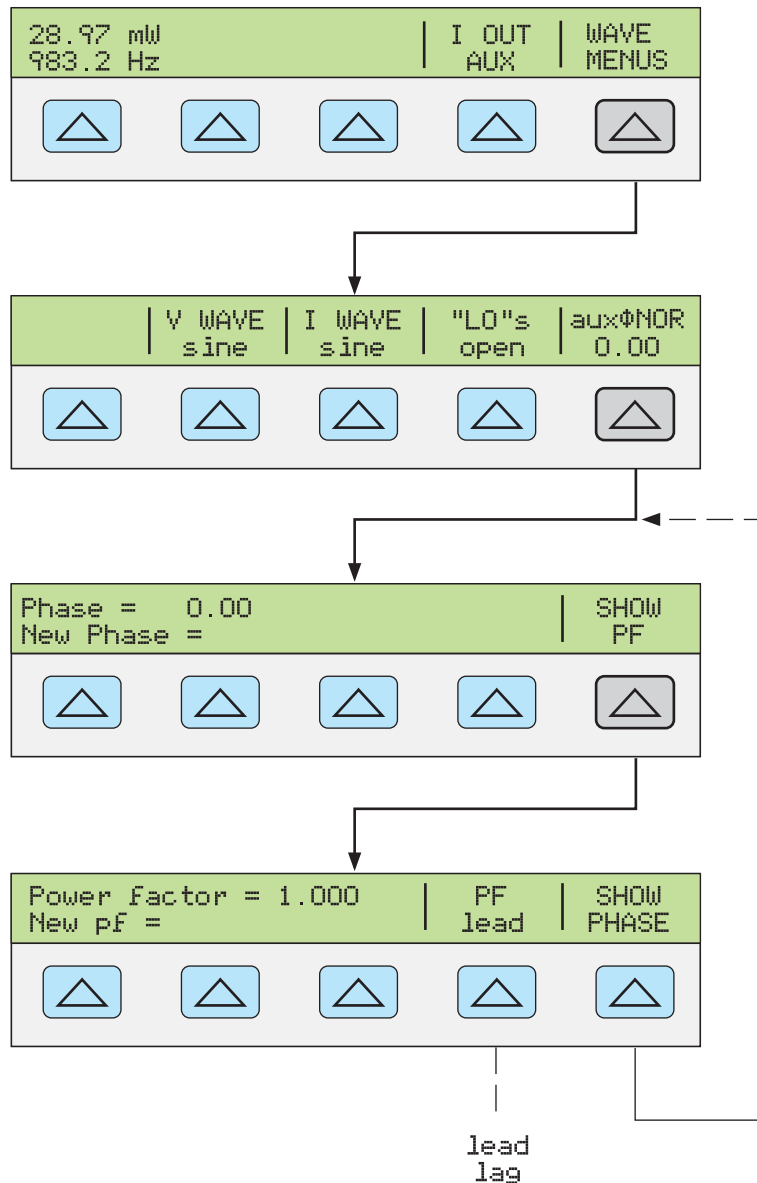

nn110f.eps

Entering a Phase Angle

Complete the following procedure to enter a phase shift in degrees. This procedure assumes you have already sourced a dual ac voltage or ac power output.

1. Press the softkey WAVE MENUS, opening the waveform menu.
2. Press the softkey PHASE, opening the phase entry menu.
3. Press the numeric keys and decimal point key to enter the desired phase angle (maximum five numeric keys). For example, 123.45.
4. Press $\boxed{+/-}$ to select leading (+) or lagging (-) phase shift (default is +).
5. The Control Display now shows the value of your entry. For example, a leading phase angle of 123.45 degrees (below).

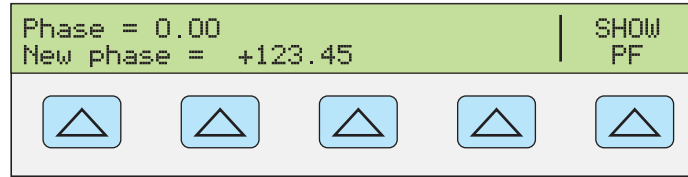

nn111f.eps

6. Press **[ENTER]**. The calibrator clears your entry from the “New phase =” line and copies it to the “Phase =” line of the Control Display.
7. Press **[CE]** one or more times to return to previous menus.

Entering a Power Factor

Complete the following procedure to enter a phase shift as a power factor (PF). PF = Cosine Φ , where Φ is the phase shift. This procedure assumes you have already sourced a dual ac voltage or ac power output using sine waves as the waveform.

1. Press the softkey WAVE MENUS, opening the waveform menu.
2. Press the softkey PHASE, opening the phase entry menu.
3. Press the softkey SHOW PF, opening the power factor entry menu.
4. Press the decimal point key and numeric keys to enter the desired power factor (maximum three numeric keys). For example, .678.
5. Press the softkey PF to toggle between a leading (lead) or lagging (lag) power factor (default is lead).
6. The Control Display now shows the value of your entry. For example, a leading power factor of .678 (below).

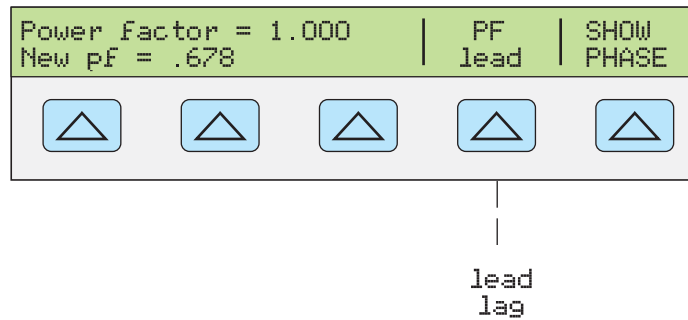

nn112f.eps

7. Press **[ENTER]**. The calibrator clears your entry from the “New pf=” line and copies it to the “Power Factor =” line of the Control Display.
8. Press **[PREV MENU]** one or more times to return to previous menus.

Editing and Error Output Settings

All Calibrator outputs except resistance can be edited using the front-panel Edit Field knob and associated **[◀]**, **[▶]**, and **[EDIT FIELD]** keys. In addition, multiply **[x10]** and divide **[÷10]** keys edit the output by decades. The difference between the original output (reference) and edited output is displayed as an “error” between the two settings. This allows you to edit a value to achieve a correct reading at the UUT and thereby calculate an error in $\pm\%$ or ppm (parts per million) if it is less than ± 1000 ppm. Table 4-3 lists the actions that cause the Calibrator to exit the error mode and return to the original reference output, or to output a new reference, as selected.

Table 4-3. Keys That Exit Error Mode

Keys	Action
	Returns to the previous reference value.
+	Establishes a new reference.
A new keypad entry +	Establishes a new reference.
	Establishes the present output as a new reference.
	Sets the Calibrator to ten times the reference value and establishes a new reference.
	Sets the Calibrator to one-tenth the reference value and establishes a new reference.
	Returns to the power-up state.

Editing the Output Setting

When you initially source an output from the Calibrator, you enter a specific value. For example, 10.0000 V dc. To edit the output value for voltage and current to suit your application, turn the front-panel Edit Field knob clockwise to increase the value or counter-clockwise to decrease the value. (The Edit Field controls will not operate if you are in any setup function. Press the key one or more times to exit a setup function.)

To select a higher order digit, use an Edit Field cursor key or . The output digit in edit is always underlined (see below).

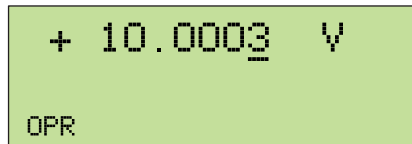

nn115f.eps

The momentary display of the letter u in the Output Display when editing during OPR (Operate) indicates “unsettled,” that is, the Calibrator output is settling with a new value.

Displaying the UUT Error: AC and DC Voltage and Current Output

When you edit the output value, the Control Display shows the difference between the reference value (the value you originally entered) and the edit value (the value shown in the Output Display), displaying error difference in parts per million (ppm) or percent (%). For example, if ERR UNI is set to >100 ppm, the error will be displayed in ppm up to 99 and then the error will change to 0.0100% at 100 ppm. This allows you to edit the output such that the UUT displays the expected value and thus give an indication of the UUT accuracy.

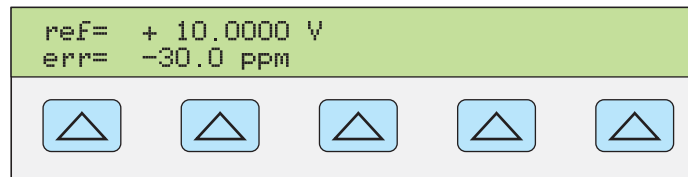

nn116f.eps

For example, an edited difference of .0003 volts for an output of 10.0000 V represents $0.0003/10.0000=0.000030$, or 30 parts per million. The sign is negative (-30.0 ppm) because the output necessary to display 10.0000 at the UUT shows the UUT is reading below the output value. When the reference is negative, the error sign is relative to the

magnitude. For example, if the reference is -10.0000 V and the output display is -10.0003, the error is -30 ppm.

Displaying the UUT Error: Resistance Output

In the resistance output function, the edit controls produce a display of the UUT error in a similar way, except the output of the calibrator does not change as you turn the knob. Instead, a reading on the Control Display changes, allowing you to match it to the reading on the UUT. As you change the reading, the calibrator computes and displays UUT error.

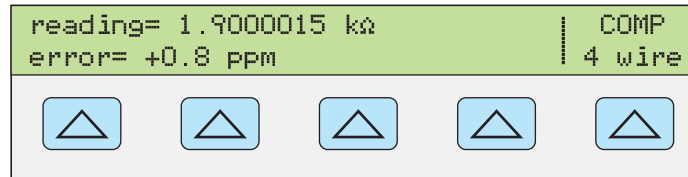

gew357.eps

Using Multiply and Divide

The Calibrator output value (or reference value if you have edited the output) can be multiplied by a factor of 10 by pressing the $\times 10$ key. Similarly, the output value (or reference value if you have edited the output) can be divided a factor of 10 by pressing the $\div 10$ key. The output will be placed in STBY (Standby) if the multiplied value exceeds 33 V. Press the $\overline{\text{OPR}}$ key if you wish to continue. This feature is useful for UUTs with ranges organized in decades.

Setting Voltage and Current Limits

An output limit feature is available to help prevent accidental damage to a UUT from overcurrent or overvoltage conditions. This feature allows you to preset the maximum positive and negative allowable voltage or current output. Entry limits you set prevent any output greater than the limit from being activated by entry through the front-panel keys or the output adjustment controls. Positive limits for voltage and current set the limits for ac voltage and current. Your limit selections are saved in the nonvolatile memory. Voltage limits are expressed as rms values, and any voltage offsets are ignored.

To set voltage and current entry limits, proceed as follows:

1. Press $\overline{\text{RESET}}$ to clear any output from the Calibrator.
2. Press $\overline{\text{SETUP}}$. Press the softkey INSTMT SETUP to open the setup submenus.
3. Press the softkey OUTPUT SETUP to open the output setup submenus.
4. Press the softkey SET LIMITS to open the set limits menu (below).

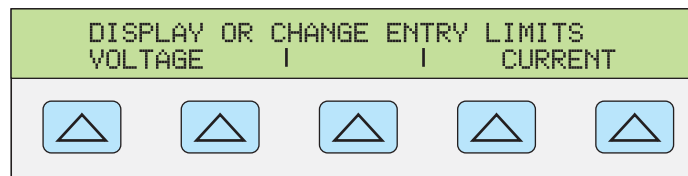

nn117f.eps

5. To Limit Voltage (applies to both dc and ac voltages). Press a softkey under VOLTAGE to open the voltage limits menu (below).

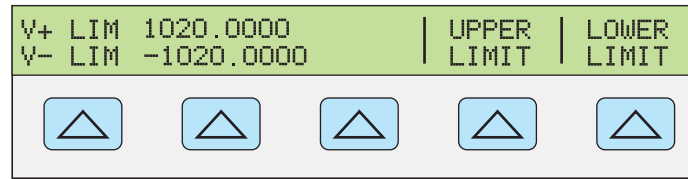

nn118f.eps

- a. Press the “Upper Limit” or the “Lower Limit” softkey, as desired, and enter the new limit.
 - b. Press **ENTER** then **PREV MENU** one or more times to return to a previous menu.
6. To Limit Current (applies to both dc and ac currents). Press a softkey under CURRENT to open the current limits menu (below).

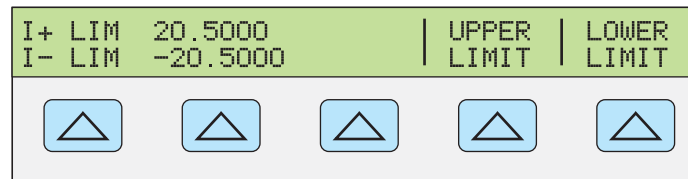

nn119f.eps

- a. Press the “Upper Limit” or the “Lower Limit” softkey, as desired, and enter the new limit.
- b. Press **ENTER** then **PREV MENU** one or more times to return to a previous menu.

Chapter 5

Remote Operations

Title	Page
Introduction.....	5-3
Setting up the RS-232 Host Port for Remote Control.....	5-4
Configuring the Ethernet (LAN) Port.....	5-5
Setting the IP Address	5-6
Selecting Dynamic Host Configuration Protocol (DHCP).....	5-6
Setting a Static Internet Address.....	5-7
Setting the LAN Subnet Mask.....	5-7
Reading the Domain Name	5-7
Configuring the Host Name.....	5-7
Reading the MAC Address.....	5-8
Configuring the LAN Default Gateway	5-8
Configuring the General Network Socket Port.....	5-8
Establishing an Ethernet Connection.....	5-9
Terminating an Ethernet Connection.....	5-9
Changing Between Remote and Local Operation.....	5-10
Local State.....	5-10
Local and Lockout State.....	5-10
Remote State.....	5-10
Remote with Lockout State	5-10
RS-232 Interface Overview	5-11
Using Commands.....	5-11
Types of Commands.....	5-11
Device-Dependent Commands.....	5-11
Common Commands.....	5-12
Query Commands.....	5-12
Compound Commands.....	5-12
Coupled Commands	5-12
Overlapped Commands.....	5-12
Sequential Commands.....	5-13
Commands that Require the Calibration Switch.....	5-13
Command Syntax	5-13
Parameter Syntax Rules	5-13
Extra Space or Tab Characters.....	5-15
Terminators	5-15
Incoming Character Processing.....	5-15
Response Message Syntax	5-15
Checking 5080A Status	5-17
Serial Poll Status Byte (STB).....	5-17

Master Summary Status	5-19
Service Request Enable Register (SRE).....	5-19
Programming the STB and SRE.....	5-19
Event Status Register (ESR)	5-19
Event Status Enable (ESE) Register.....	5-19
Bit Assignments for the ESR and ESE.....	5-20
Programming the ESR and ESE.....	5-20
Instrument Status Register (ISR).....	5-20
Instrument Status Change Registers.....	5-20
Instrument Status Change Enable Registers.....	5-21
Bit Assignments for the ISR, ISCR, and ISCE	5-21
Programming the ISR, ISCR, and ISCE	5-22
Output Queue.....	5-22
Error Queue	5-22
Input Buffer Operation	5-22

⚠⚠ Warning

The 5080A Calibrator (hereafter referred to as “The Calibrator”) can produce voltages up to 1020 V rms and must be programmed with caution to prevent hazardous voltages from being produced without sufficient warning to the operator.

Write programs carefully and test them extensively to ensure safe operation of the Calibrator. Fluke suggests that you include error-catching routines in your programs. These error-catching routines will help you identify programming errors that may cause the Calibrator to behave other than intended. You can program the Calibrator to cause an SRQSTR when an error is detected by setting the Service Request Enable (SRE) register.

Introduction

This chapter describes methods for operating the Calibrator by remote control. Remote control can be interactive, with the user controlling each step from a terminal, or under the control of a computer program running the Calibrator in an automated system. The Calibrator rear panel has two ports for remote operations: An Ethernet port and an RS-232 serial port.

RS-232 The serial port connects the PC and Calibrator. You can write your own computer programs using the command set, or operate the PC as a terminal and enter individual commands, or you can purchase optional Fluke MET/CAL or 5080/CAL software for RS-232 system operations. Typical RS-232 remote configurations are shown in Figure 5-1.

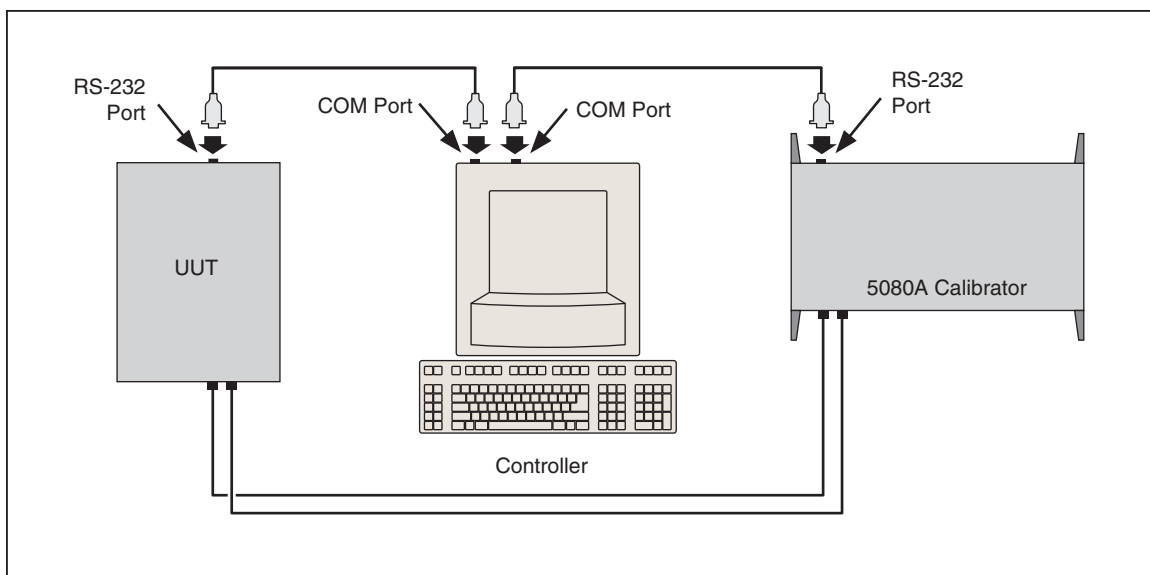

Figure 5-1. Typical RS-232 Remote Control Connections

gew326.eps

After configuring the Ethernet or RS-232 port for remote operation, you are ready to begin using the command set. The operation of the command set is described under “Using Commands” in this chapter. A summary of remote commands is in Chapter 6, “Remote Commands.”

Setting up the RS-232 Host Port for Remote Control

The Calibrator is fully programmable over an RS-232 link with a PC via the rear-panel serial port (Figure 5-1). You can enter individual commands from a terminal, write your own programs using, for example, a Windows-based language such as Visual Basic, or run optional Windows-based Fluke software such as 5080/CAL or MET/CAL.

The RS-232 cable length for the port should not exceed 15 meters (50 feet), although longer cable lengths are permitted if the load capacitance measured at a connection point (including signal terminator) does not exceed 2500 pF.

Complete the following procedure to set up the serial port. The RS-232 parameters you select here must match the parameters set for the PC COM port. The factory defaults (shown on the display below) are 9600 baud, 8 data bits, 1 stop bit, and no parity. Other parameters include flow control, EOL (end-of-line) character, and EOF (end-of-file) characters.

1. Turn the Calibrator power on. You may operate the Calibrator during warmup, but specifications are not guaranteed until warmup is complete.
2. Press **SETUP** on the Calibrator front panel.
3. Negotiate the softkey selections shown below to select the serial port for remote operation, then continue to step 4.

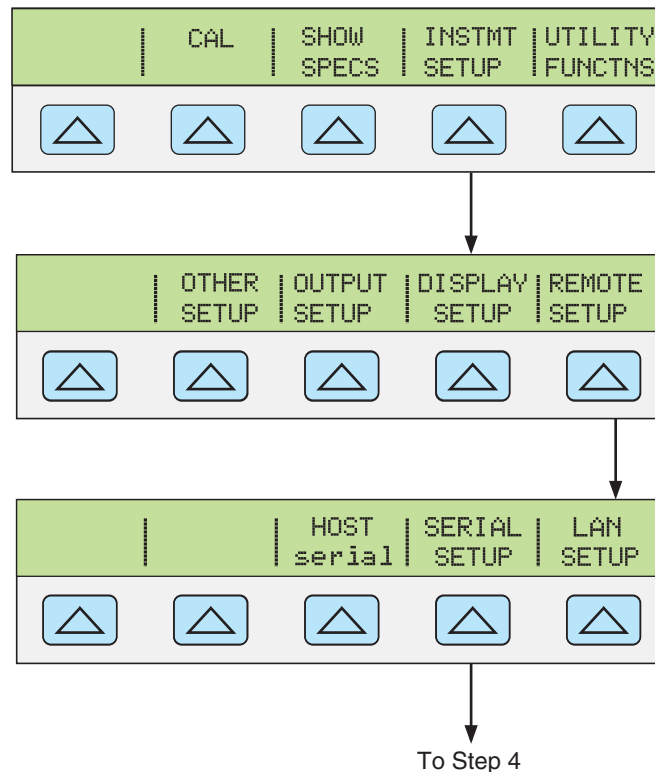

gew329.eps

4. Negotiate the softkey selections shown below to select the HOST serial port parameters to match the PC COM parameters. (Individual softkey functions are discussed in Chapter 3, "Features.") If operating the port with a computer program instead of individual commands from a terminal, select Remote I/F comp (factory default).

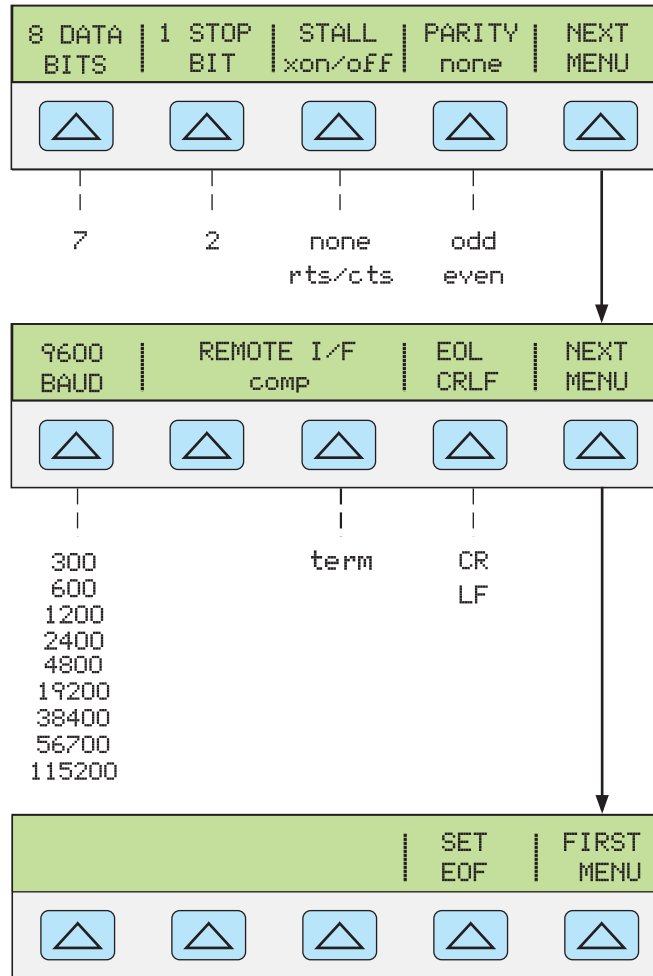

gew328.eps

5. Press **PREV MENU** (not **ENTER**) several times until the message **STORE CHANGES/DISCARD CHANGES** appears or, if there were no changes, clear the display. If you select **STORE CHANGES**, the serial and host port setting are saved in the instrument non-volatile memory.

Configuring the Ethernet (LAN) Port

The Calibrator can be remotely controlled through the LAN port on the Calibrator’s rear panel. To select the LAN port as the remote control port, see the “Selecting the Remote Interface” section above.

Configuring the LAN port is accomplished through the Instrument Setup function. The selectable LAN port parameters are: DHCP (Dynamic Host Configuration Protocol), IP Address, Net mask, Host Name, Mac Address, Gateway, Port number, and Domain.

When setting IP addresses, subnet masks, and default gateways on the Calibrator, keep in mind they are stored as 32-bit binary numbers and expressed as four 3-digit segments in dot-notation form. For example, xxx.xxx.xxx.xxx, where xxx is a byte value, is stored as a 32-bit binary number.

To set the LAN port parameters:

1. Push **SETUP**.
2. Push the softkey labeled **INSTMT SETUP**.

3. Push the softkey labeled **REMOTE SETUP**.
4. Push the softkey labeled **LAN SETUP**. The LAN parameters are set through the two softkey menus shown in Figure 5-2.

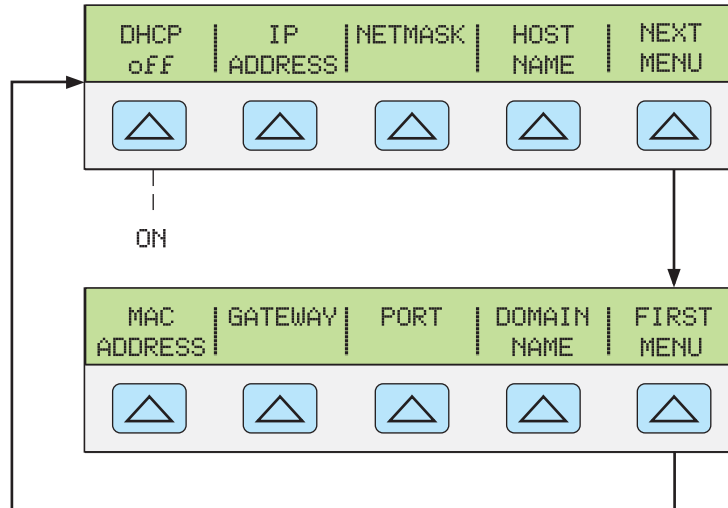

Figure 5-2. Menus to Set LAN Parameters

gew336.eps

Note

When addressing some LAN addresses, computers will often interpret 0's in the IP address as OCTAL values. As an example, if you configure your IP address from the front panel as 129.196.017.023 and then attempt to establish a connection to the calibrator, you should connect using the IP address 129.196.17.23. Attempting to establish a connection to 129.196.017.023 may result in a connection request to 129.196.15.19.

Setting the IP Address

An internet (IP) address is required for all internet and TCP/IP communications. If DHCP is enabled, the Calibrator will use the dynamic address supplied by the DHCP server. However, if the DHCP server fails to supply the address, or DHCP is disabled, the currently configured static IP address will be used.

Selecting Dynamic Host Configuration Protocol (DHCP)

Dynamic Host Configuration Protocol (DHCP) is a client-server protocol that eliminates having to manually set permanent/static IP addresses. The DHCP server provides configuration parameters (dynamic IP address, subnet mask, and default gateway IP addresses) which are required for a client to participate in an IP network.

Using DHCP is the easiest way to configure the Calibrator for remote communication through the LAN interface. DHCP is disabled when the Calibrator is shipped from the factory. When connected to a network, and the LAN port is enabled, the Calibrator will try and retrieve the parameters from a DHCP server necessary for communications. If the parameters can't be obtained, the Calibrator switches to the parameters that were manually entered into the Calibrator.

To disable or enable DHCP on the Calibrator:

From the LAN menu, push the softkey labeled **DHCP** to toggle between on and off. If DHCP is already enabled, then **on** will be shown in the softkey label.

Note

After changing any Ethernet setting (except the socket port), the Calibrator must be powered off and on again, using the front-panel power switch, to make the change active.

Setting a Static Internet Address

The Calibrator comes from the factory with 169.254.001.001 in the static IP address register.

Note

If you are planning to use the Calibrator on a corporate LAN and do not wish to use DHCP, contact your network administrator for a static IP address to be used exclusively by your Calibrator. DHCP must be disabled to set a static IP address.

To change the Calibrator's static IP Address:

1. From the LAN menu, push the softkey labeled **IP ADDRESS**.
2. Use the numeric keypad to enter the IP address and then push .

If you make a mistake entering the IP address, you must press push .

Note

The IP address is stored in non-volatile memory, and does not change when power is removed and reapplied to the Calibrator or when the Calibrator receives an *RST command.

Setting the LAN Subnet Mask

If communication between the host computer and the Calibrator passes through a router or gateway, and DHCP is disabled, you must set the subnet mask and default gateway address on both the host computer and the Calibrator. Get the correct subnet mask and gateway address from your network administrator.

The LAN Subnet Mask is a 32-bit number. This number is represented as four 3-digit segment numbers on the front-panel display. The default subnet mask set at the factory is 255.255.254.0.

To change the Calibrator's subnet mask:

1. From the LAN menu, push the softkey labeled **NETMASK**.
2. Use the numeric keypad to enter the IP address and then push .

If you make a mistake entering the IP address, you must push or and go back to step 1 to start entering the address again.

The new Subnet Mask will not take effect until the Calibrator has been powered down and back up again using the front-panel power switch.

Reading the Domain Name



The Domain Name is supplied by the DHCP server and cannot be changed. To read the domain name:



1. From the LAN menu, push **NEXT MENU** to show the second LAN menu.
2. Push the softkey labeled **DOMAIN NAME**.

Configuring the Host Name

The Host Name is the host portion of the domain name, which is translated into an IP address. The Calibrator's default host name is "FLUKE-5080A-snxxxx".

To change the Host Name:

1. From the LAN menu, push the softkey labeled **HOST NAME**.
2. Push .
3. Push  and  to position the cursor under a character in the host name shown in the display.
4. Use the rotary knob to change the character to a letter, number, dash, or space.

Push  and  to move the cursor to another character.

When the characters in the host name are set, push .

Note

It is not necessary to change all excess characters in a name that is longer than the new name to a space to remove the extra characters. Put a single space in place of the first excess character in the old name and then push . All characters after the space are automatically removed from the name.

The new Host Name will not take effect until the Calibrator has been powered down and back up again using the front-panel power switch.

Reading the MAC Address

The MAC Address is set at the factory and cannot be changed. To read the MAC Address, push the softkey labeled **MAC ADDRESS** to show the address.



Configuring the LAN Default Gateway

The default gateway IP address is the IP address of a gateway (router) attached to the same network as the device. When the Calibrator detects that a host computer is not on the same network (using the network number), the data is sent through the gateway to reach the host computer.

The default for the Calibrator is “0” (no gateway, and subnetting is not being used).

To set the LAN Default Gateway address:

1. From the LAN menu, push **NEXT MENU** to show the second LAN menu.
2. Push the softkey labeled **GATEWAY**.
3. Use the numeric keypad to enter the gateway IP address and then push .

If you make a mistake entering the gateway IP address, you must push  or  and go back to step 1 to start entering the address again.

The new gateway address will not take effect until the Calibrator has been powered down and back up again using the front-panel power switch.

Configuring the General Network Socket Port

In order to communicate with each other, a host computer and the Calibrator must use the same socket port number. The default port is 3490. Typically, the default port does not need to be changed. If the socket port must be changed, enter the Socket Port number supplied by your network administrator.

To change the Socket Port number:

1. From the LAN menu, push **NEXT MENU** to show the second LAN menu.
2. Push the softkey labeled **PORT**.
3. Use the numeric keypad to enter a new port number and push . The port number must be between 1024 to 65535.

If you make a mistake entering the port number, you must push **PREV MENU** or **CE** and go back to step 1 to start entering the port number again.

The new Network Socket Port becomes effective immediately.

Note

The Network Socket Port Number is stored in non-volatile memory.

Establishing an Ethernet Connection

The easiest method of establishing an Ethernet connection with the Calibrator is through the commonly available program: Telnet. Telnet is a client-server protocol, based on TCP. The Telnet Protocol provides a fairly general, bi-directional, eight-bit byte oriented communications facility. Telnet is available on all UNIX servers and on most PCs.

Telnet clients typically connect to hosts on socket port 23. The LAN connection to the Calibrator must be established using the specified Network Socket Port. See the “Configuring the General Network Socket Port” section above. When the remote interface port is changed to LAN from the Calibrator’s front panel, a LAN server is initiated in the Calibrator which listens for client connections on the socket port at the specified IP address.

To establish a LAN connection to the Calibrator from a computer using either UNIX, LINUX, or MS-DOS command prompts, perform the following procedure:

1. On the Calibrator’s front panel, change the remote interface port to LAN
2. At the command prompt on the client computer, enter:

```
telnet <IP Address> <Socket Port>
```

Alternatively, if you are using DHCP and would like to connect using the host name rather than the IP address, from the computer command prompt enter:

```
telnet <Host Name.Domain Name> <Socket Port>
```

As an example, if you know the IP address is 129.196.136.131 and the Socket Port is set to 3490, enter the following at a command prompt from any client computer:

```
telnet 129.196.136.131 3490
```

If you are using DHCP and the host name is **FLUKE-5080A-snxxxx** and the fully qualified domain name is **FLUKE-5080A-snxxxx.na.flukecorp.com** and the Socket Port is set to **3490**, enter the following at the computer command prompt:

```
telnet FLUKE-5080A-snxxxx.na.flukecorp.com 3490
```

Once the internal LAN server connects with the client computer, the LAN server will reject any other connection attempts by other computers and will “tunnel” a channel to the connected computer. This prevents multiple computers from trying to control the Calibrator.

Terminating an Ethernet Connection

When you wish to terminate the Ethernet connection, you may do so one of two ways:

1. Change the Calibrator’s remote interface port to something other than LAN
2. Terminate the Telnet session on the client computer

If you have established a LAN connection to the Calibrator using Telnet and change the remote interface port using the Calibrator’s front panel, the LAN server in the Calibrator will automatically terminate the Telnet session on the client computer.

On the other hand, you may wish to terminate the Telnet session on the client computer

but maintain the current LAN remote interface port configuration. Client Telnet session termination can vary from computer to computer, but typically terminating the shell (or command window in DOS) will terminate the telnet session. When the client terminates the Telnet session, the LAN server in the Calibrator will go back into *listen* mode waiting for a new client to make a LAN connection request.

Changing Between Remote and Local Operation

In addition to local mode (front-panel operation) and remote, the Calibrator can be placed in a local lockout condition at any time by command of the controller. Combined, the local, remote, and lockout conditions yield four possible operating states described as follows.

Local State

The Calibrator responds to local and remote commands. This is normal front-panel operation. All remote commands are allowed to execute.

Local and Lockout State

Local with lockout is identical to local, except the Calibrator will go into the remote with lockout state instead of the remote state when it receives a remote command.

Remote State

When the Calibrator is placed in remote, either via RS-232/Ethernet REMOTE command, it enters the remote state. In the remote state, the Output Display continues to display the output setting or measurement as in local operation. The Control Display changes to:

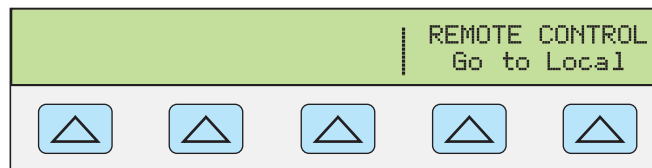

nn325f.eps

The left side of the Control Display shows information regarding the present output function. However, front-panel operation is restricted to use of the power switch and the "Go To Local" softkeys. Pressing either of these softkeys, using RS-232/Ethernet to send the command LOCAL returns the Calibrator to the local state.

Remote with Lockout State

When the Calibrator is placed in lockout, via the remote command, the 5080A front-panel controls are totally locked out. In remote with lockout, the Control Display changes to:

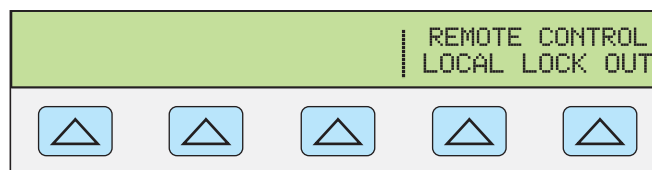

gew334f.eps

The left side of the Control Display shows information regarding the present output function. However, front-panel operation is restricted to use of the power switch. To return the Calibrator to the local with lockout state, send the RS-232/Ethernet LOCAL command.

Table 5-1 summarizes the possible Remote/Local state transitions.

Table 5-1. Operating State Transitions

From	To	Front Panel	Serial Command
Local	Remote		REMOTE
	Local with Lockout		LOCKOUT
Remote	Local	Go to Local Softkey	LOCAL
	Remote with Lockout		LOCKOUT
Local with Lockout	Local		LOCAL
	Remote with Lockout		REMOTE
Remote with Lockout	Local		LOCAL
	Local with Lockout		

RS-232 Interface Overview

The Calibrator RS-232 port is designed in accordance with EIA (Electronic Industries Association) standard RS-232. RS-232 is a serial binary data interchange operating from 300 to 115200 baud (selectable), and distances up to 50 feet. The Calibrator rear-panel serial port is configured as DTE (Data Terminal Equipment). See Appendix B for RS-232 cable and connector information. For detailed information, see the EIA standard RS-232.

Using Commands

Communications between the controller and the Calibrator consists of commands, queries, and interface messages. Although the commands are based on the 488.2 standard, they can be used on either the RS-232 or Ethernet interface. (For more information on command structures, see the IEEE 488.2 standard.)

Refer to Chapter 6, “Remote Commands” when you require additional information about command references used this chapter.

All commands and units may be entered in UPPER or lower case.

There are four specific remote control configurations that use commands, queries and interface messages: RS-232 Terminal Mode and RS-232 Computer Mode.

RS-232 Terminal Mode The RS-232 terminal mode is an interactive mode where an operator inputs commands, with immediate returns for requested information (queries) and interface messages.

RS-232 Computer Mode The RS-232 computer mode is used when the Calibrator is operated by computer program. In this mode, requested information is returned by query, and interface messages are queued and returned by command.

Types of Commands

The commands for the Calibrator can be grouped into one or more categories, depending on how they function. Each category is described below

Device-Dependent Commands

Device-dependent commands are unique to the Calibrator. An example of a device-dependent command is:

OUT 100 V, 1 A, 60 HZ

This command instructs the Calibrator to source 100 watts of ac power.

Common Commands

Common commands are defined by the IEEE 488.2 standard and are common to most bus devices. Common commands always begin with an * character. An example of a common command is:

*IDN?

This command instructs the Calibrator to return the instrument identification string.

Query Commands

Query commands request information, which is returned as the command executes, or placed in a buffer until requested. An example of a query, which always ends with a question mark, is:

RANGE?

This command returns the Calibrator primary and secondary outputs.

Compound Commands

A compound command is two or more commands in a single command line. For example, the following two commands could be entered individually,

```
OUT 1 V, 60 HZ
OPER
```

With these commands the Calibrator sources 1 V ac at 60 Hz, and then goes into operate, or they could be combined into a compound command as follows:

```
OUT 1 V, 60 HZ ; OPER
```

In the previous commands using a semi-colon as a separator, care must be taken when a compound command includes any of the coupled commands. (See “Coupled Commands.”)

Coupled Commands

A coupled command refers to two or more commands that appear in a compound command (see “Compound Commands”) that perform actions that could interfere with each other causing a fault. Commands in a compound command are separated by using the ; character. Compound commands using only coupled commands are not order-dependent.

The coupled commands are:

```
CUR_POST    DBMZ    OUT
```

Overlapped Commands

Commands that begin execution but require slightly more time to complete are called overlapped commands, because they can be overlapped by the next command before they have completed execution.

The overlapped commands are:

CUR_POST	LOWS	RANGELCK
DBM	MULT	*RST
DPF	OLDREF	STBY
EARTH	OPER	ZCOMP
INCR	OUT	
LCOMP	PHASE	

You can use the command `*WAI` to wait until the overlapped command has completed execution before executing the next command. For example:

```
OUT 1 V, 1 A, 60 HZ ; *WAI
```

You can also use the status commands `*OPC` and `*OPC?` to detect completion of overlapped commands. (See “Checking 5080A Status.”)

Sequential Commands

Commands that execute immediately are called sequential commands.

The majority of the commands are sequential.

Commands that Require the Calibration Switch

The following commands do not work unless the rear-panel CALIBRATION switch is in the ENABLE position:

```
CLOCK      (when setting date but not time)
FORMAT ALL
FORMAT CAL
*PUD
```

Attempting to use any of these commands with the CALIBRATION switch in the NORMAL position logs an error into the error queue. (Or it returns the error message if in the RS-232 Terminal Mode.)

Command Syntax

The following syntax rules apply to all the remote commands. Information about syntax of response messages is also given.

Parameter Syntax Rules

Table lists the units accepted in command parameters and used in responses. All commands and units may be entered in UPPER or lower case.

Table 5-2. Units Accepted in Parameters and Used in Responses

Units	Meaning
HZ	Frequency in units of hertz
KHZ	Frequency in units of kilohertz
MHZ	Frequency in units of megahertz
UV	Volts in units of microvolts
MV	Volts in units of millivolts
V	Volts in units of volts
KV	Volts in units of kilovolts
UA	Current in units of microamperes
MA	Current in units of milliamps
A	Current in units of amps
PCT	Percent
PPM	Parts-per-million
DBM	Volts in units of decibels referenced to 1 milliwatt into 600 Ω load
OHM	Resistance in units of ohms
KOHM	Resistance in units of kilohms
MOHM	Resistance in units of megohms
NS	Period in units of nanoseconds
US	Period in units of microseconds
MS	Period in units of milliseconds
S	Period in units of seconds

General Rules The general rules for parameter usage is as follows:

1. When a command has more than one parameter, the parameters must be separated by commas. For example: `OUT 1V, 2A`
2. Numeric parameters may have up to 15 significant digits and their exponents can be in the range $\pm 1.0E\pm 20$.
3. Including too many or too few parameters causes a command error.
4. Null parameters cause an error, for example, the adjacent commas in `OUT 1V, , 2A`
5. Expressions, for example `4+2*13`, are not allowed as parameters.
6. Binary Block Data can be in one of two forms: Indefinite Length and Definite Length format (both IEEE-488.2 standards).

Indefinite Length The Indefinite Length format accepts data bytes after the #0 until the ASCII Line Feed character is received with an EOI signal (for RS-232 just a line feed or carriage return will terminate the block).

Definite Length The Definite Length format specifies the number of data bytes. The data bytes are preceded by #n and an n-digit number. The n-digit number identifies

how many data bytes follow. For examples, see the *PUD command descriptions in Chapter 6.

Extra Space or Tab Characters

In the command descriptions in Chapter 6, parameters are shown separated by spaces. One space after a command is required (unless no parameters are required). All other spaces are optional. Spaces are inserted for clarity in the manual and may be left in or omitted as desired. You can insert extra spaces or tabs between parameters as desired. Extra spaces within a parameter are generally not allowed, except for between a number and its associated multiplier or unit. Chapter 6 contains examples for commands whose parameters or responses are not self-explanatory.

Terminators

Table 5-3 summarizes the terminator characters for the RS-232 and Ethernet remote interfaces.

Table 5-3. Terminator Characters

Terminator	ASCII Character		Control Command	Language Command
Function	Number	Program	Terminator	Terminator
Carriage Return (CR)	13	Chr(13)	<Cntl> M	\n
Line Feed (LF)	10	Chr(10)	<Cntl> J	\r
Backspace (BS)	8	Chr(8)	<Cntl> H	\b
Form Feed (FF)	12	Chr(12)	<Cntl> L	\f
Examples:				
RS-232 Terminal Mode OUT 1 V, 60 Hz <Enter>				
RS-232 Computer Mode Comm1.Output = "OUT 1 V, 60 HZ" + Chr(10)				

RS-232/Ethernet Interface The Calibrator returns an EOL (End of Line) character with each response to the PC. This is selectable as Carriage Return (CR), Line Feed (LF) or both CRLF. (See "RS-232 Host Port Setup Procedure" earlier in this chapter.) Commands sent to the Calibrator must end in either a CR or LF, or both. (See Table 5-3.)

Incoming Character Processing

The Calibrator processes all incoming data as follows (except Binary Block Data as described under Parameter Syntax Rules):

1. The most significant data bit (DIO8) is ignored.
2. All data is taken as 7-bit ASCII.
3. Lower-case or upper-case characters are accepted.
4. ASCII characters whose decimal equivalent is less than 32 (Space) are discarded, except for characters 10 (LF) and 13 (CR) and in the *PUD command argument. Binary Block Data allows all characters in its argument and terminates in a special way.

Response Message Syntax

In the command descriptions in Chapter 6, responses from the Calibrator are described wherever appropriate. In order to know what type of data to read in, refer to the first part of the entry under "Response" in the tables. The response is identified as one of the data types in Table 5-4.

Table 5-4. Response Data Types

Data Type	Description
Integer	<p>Integers for some controllers or computers are decimal numbers in the range -32768 to 32768.</p> <p>Responses in this range are labeled Integer.</p> <p>Example: *ESE 123; *ESE?</p> <p>returns: 123</p>
Floating	<p>Numbers that may have up to 15 significant figures plus an exponent that may range from $\pm E20$.</p> <p>Example: POWER?</p> <p>returns: 1.4293E+00</p>
String	<p>Any ASCII characters including quotation mark delimiters.</p> <p>Example: SRQSTR "SRQ from 5080A"; SRQSTR?</p> <p>returns: "SRQ from 5080A"</p>
Character Response Data (CRD)	<p>This type of response is always a keyword.</p> <p>Example: OUT 10V, 100HZ; FUNC?</p> <p>returns: ACV</p>
Indefinite ASCII (IAD)	<p>Any ASCII characters followed by EOM. Queries with this type of response MUST be the last Query in a program message.</p> <p>Example: *OPT?</p> <p>CAL reports and lists which contains Line Feeds are typically of this type.</p>
Binary Block Data	<p>A special data type defined by the IEEE-488.2 standard. This type is used in *PUD? query. It is defined as follows:</p> <p>#(non-zero digit) (digits) (user data)</p> <p>The non-zero digit specifies the number of characters that will follow in the <digits> field. Characters allowed in the digits field are 0 through 9 (ASCII 48 through 57 decimal). The value of the number in the <digits> field in decimal defines the number of user data bytes that follow in the <user data> field. The maximum response is 64 characters.</p> <p>Example: *PUD "test1"; *PUD?</p> <p>returns: #205test1</p>

Checking 5080A Status

The programmer has access to status registers, enable registers, and queues in the Calibrator to indicate various conditions in the instrument as shown in Figure 5-2. Some registers and queues are defined by the IEEE-488.2 standard. The rest are specific to the Calibrator. In addition to the status registers, a 16-element buffer called the Error Queue provides status information. Table 5-5 lists the status registers and gives the read/write commands and associated mask registers.

Table 5-5. Status Register Summary

Status Register	Read Command	Write Command
Serial Poll Status Byte (STB)	*STB?	—
Service Request Enable Register (SRE)	*SRE?	*SRE
Event Status Register (ESR)	*ESR?	—
Event Status Enable Register (ESE)	*ESE?	*ESE
Instrument Status Register (ISR)	ISR?	—
Instrument Status Change Register (ISCR)	ISCR?	—
ISCR 1 to 0 transition	ISCR0?	—
ISCR 0 to 1 transition	ISCR1?	—
Instrument Status Change Enable Register (ISCE)	ISCE?	ISCE
ISCE 1 to 0 transition	ISCE0?	ISCE0
ISCE 0 to 1 transition	ISCE1?	ISCE1

Each status register and queue has a summary bit in the Serial Poll Status Byte. Enable registers are used to mask various bits in the status registers and generate summary bits in the Serial Poll Status Byte. For RS-232 interface operation, the SRQSTR string is sent over the serial interface when the MSS bit is set. (See the SRQSTR command description in Chapter 6 for more information.)

Serial Poll Status Byte (STB)

The Calibrator sends the serial poll status byte (STB) when it responds to a serial poll. This byte is cleared (set to 0) when the power is turned on. The STB byte is defined as shown in Figure 5-4. If you are using the RS-232 as the remote control interface, transmitting the ^P character (in the Terminal mode, hold down the <Cntl> key and press P) returns the SPLSTR (Serial Poll String) and the status byte. Refer to the *STB command, and for RS-232 interface operation, the SPLSTR and SPLSTR? commands, in Chapter 6 for more information.

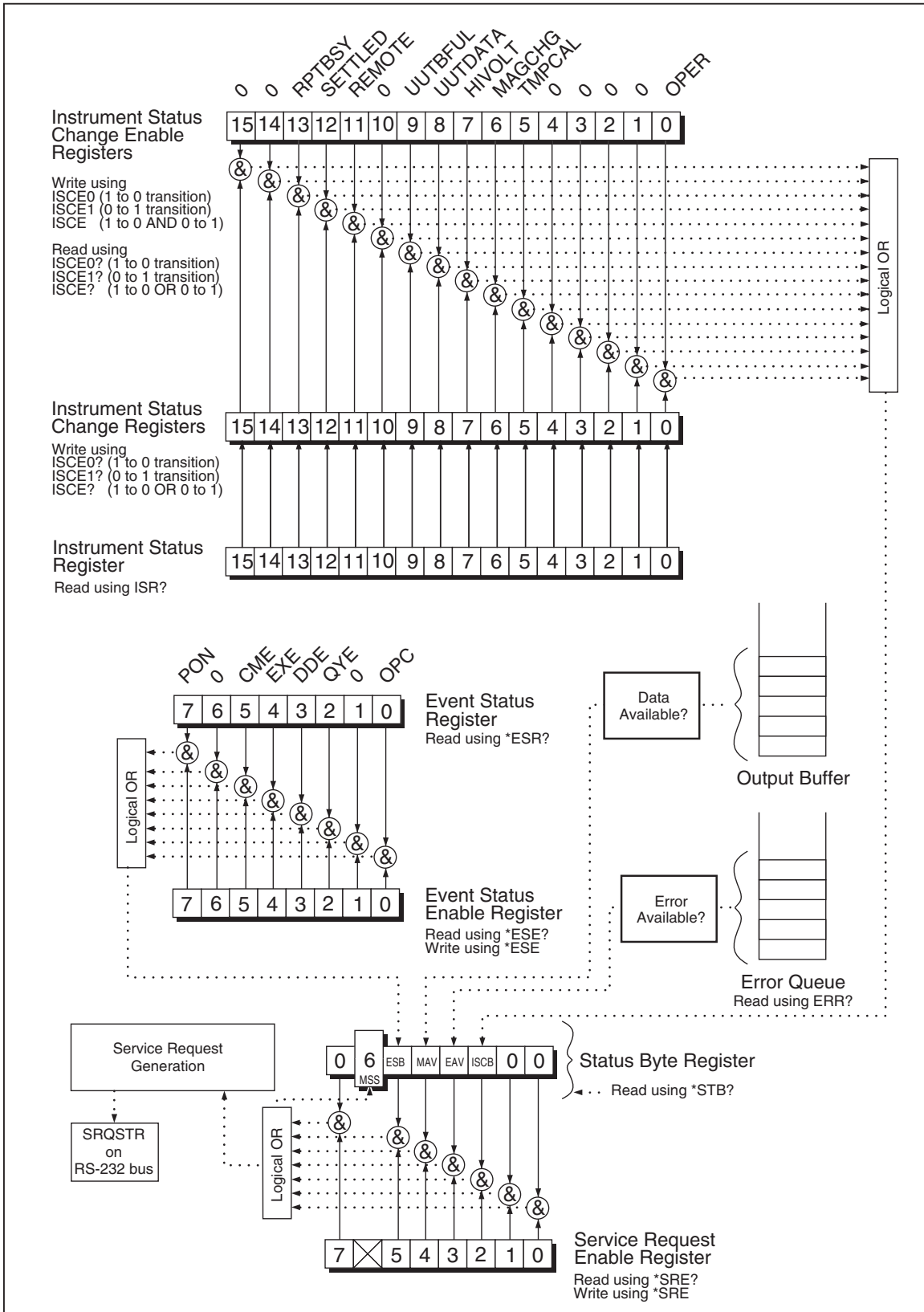

gew330.eps

Figure 5-3. Status Register Overview

7	6	5	4	3	2	1	0
0	MSS	ESB	MAV	EAV	ISCB	0	0

MSS	Master summary status. Set to 1 whenever bits ESB, MAV, EAV, or ISCB are 1 and enabled (1) in the SRE. This bit can be read using the *STB? command in serial remote control in place of doing a serial poll.
ESB	Set to 1 when one or more enabled ESR bits are 1.
MAV	Message available. The MAV bit is set to 1 whenever data is available in the 5080A's output buffer.
EAV	Error available. An error has occurred and an error is available to be read from the error queue by using the ERR? query.
OPER	ISCB One or more enabled ISCR bits are 1.

gew331.eps

Figure 5-4. Serial Poll Status Byte (STB) and Service Request Enable (SRE)

Master Summary Status

RS-232/Ethernet Remote operations using the RS-232/Ethernet interface emulate the IEEE-488 SRQ line by sending the SRQSTR string over the serial interface when the MSS bit is set. (See the SRQSTR command description in Chapter 6 for more information.)

The MSS bit is cleared only when ESB, MAV, EAV, and ISCB are 0, or they are disabled by their associated enable bits in the SRE register being set to 0.

Service Request Enable Register (SRE)

The Service Request Enable Register (SRE) enables or masks the bits of the Serial Poll Status Byte. The SRE is cleared at power up. Refer to Figure 5-4 for the bit functions.

Programming the STB and SRE

By resetting (to 0) the bits in the SRE, you can mask (disable) associated bits in the serial poll status byte. Bits set to 1 enable the associated bit in the serial poll status byte.

Event Status Register (ESR)

The Event Status Register is a two-byte register in which the higher eight bits are always 0, and the lower eight bits represent various conditions of the Calibrator. The ESR is cleared (set to 0) when the power is turned on, and every time it is read.

Many of the remote commands require parameters. Improper use of parameters causes command errors to occur. When a command error occurs, bit CME (5) in the Event Status Register (ESR) goes to 1 (if enabled in ESE register), and the error is logged in the error queue.

Event Status Enable (ESE) Register

A mask register called the Event Status Enable register (ESE) allows the controller to enable or mask bit in the ESR. When a bit in the ESE is 1, the corresponding bit in the ESR is enabled. When any enabled bit in the ESR is 1, the ESB bit in the Serial Poll Status Byte also goes to 1. The ESR bit stays 1 until the controller reads the ESR or does a device clear, a selected device clear, or sends the reset or *CLS command to the

Calibrator. The ESE is cleared (set to 0) when the power is turned on.

Bit Assignments for the ESR and ESE

The bits in the Event Status Register (ESR) and Event Status Enable register (ESE) are assigned as shown in Figure 5-5.

15	14	13	12	11	10	9	8
0	0	0	0	0	0	0	0
7	6	5	4	3	2	1	0
PON	0	CME	EXE	DDE	QYE	0	OPC

PON	Power on. This bit is set to 1 if line power has been turned off and on since the last time the ESR was read.
CME	Command error. The 5080A's remote interface encountered an incorrectly formed command. (The command ERR? fetches the earliest error code in the error queue, which contains error codes for the first 15 errors that have occurred.)
EXE	Execution error. An error occurred while the 5080A tried to execute the last command. This could be caused, for example, by a parameter being out of range. (The command ERR? fetches the earliest error in the error queue, which contains error codes for the first 15 errors that have occurred.)
DDE	Device-dependent error. An error related to a device-dependent command has occurred.
QYE	Query error. The 5080A was addressed to talk when no response data was available or appropriate, or when the controller failed to retrieve data on the output queue.
OPC	Operation complete. All commands previous to reception of a *OPC command have been executed, and the interface is ready to accept another message.

gew332.eps

Figure 5-5. Event Status Register (ESR) and Event Status Enable (ESE)

Programming the ESR and ESE

To read the contents of the ESR, send the remote command, *ESR?. The ESR is cleared (set to 0) every time it is read. To read the contents of the ESE, send the remote command *ESE?. The ESE is not cleared when it is read. When you read either register, the Calibrator responds by sending a decimal number that when converted to binary represents bits 0 through 15.

Instrument Status Register (ISR)

The Instrument Status Register (ISR) gives the controller access to the state of the Calibrator, including some of the information presented to the operator on the Control Display and the display annunciators during local operation.

Instrument Status Change Registers

There are two registers dedicated to monitoring changes in the ISR. These are the ISCR0 (Instrument Status 1-0 Change Register) and the ISCR1 (Instrument Status 0-1 Change Register). Each status change register has an associated mask register. Each ISCR is cleared (set to 0) when the Calibrator is turned on, every time it is read, and at each *CLS (Clear Status) command.

Instrument Status Change Enable Registers

The Instrument Status Change Enable registers (ISCE0 and ISCE1) are instrument status change enable mask registers for the ISCR0 and ISCR1 registers. If a bit in the ISCE is enabled (set to 1) and the corresponding bit in the ISCR makes the appropriate transition, the ISCB bit in the Status Byte is set to 1. If all bits in the ISCE are disabled (set to 0), the ISCB bit in the Status Byte never goes to 1. The contents of the ISCE registers are set to 0 at power-up.

Bit Assignments for the ISR, ISCR, and ISCE

The bits in the Instrument Status, Instrument Status Change, and Instrument Status Change Enable registers are assigned as show in Figure 5-6.

15	14	13	12	11	10	9	8
0	0	RPTBUSY	SETTLED	REMOTE	0	0	0

7	6	5	4	3	2	1	0
HIVOLT	MAGCHG	TMPCAL	0	0	0	0	OPER

RPTBUSY	Set to 1 when a calibration report is being printed to the serial port.
SETTLED	Set to 1 when the output has stabilized to within specification.
REMOTE	Set to 1 when the 5080A is under remote control.
HIVOLT	Set to 1 when the 5080A is programmed to a voltage above 33 Volts.
MAGCHG	Set to 1 when the output magnitude has changed as a result of another change. This bit is always 0 in the ISR. It changes to 1 only in the ISCR0 and ISCR1 registers.
TMPCAL	Set to 1 when the 5080A is using temporary (non-stored) calibration data.
OPER	Set to 1 when the 5080A is in operate, 0 when it is in standby.

Figure 5-6. Bit Assignments for the ISR, ISCEs, and ISCRs

gew333.eps

Programming the ISR, ISCR, and ISCE

To read the contents of the ISR, send the remote command, `ISR?`. To read the contents of the ISCR0 or 1, send the remote command, `ISCR0?`, or `ISCR1?`. To read the contents of the ISCE0 or 1, send the remote command, `ISCE0?`, or `ISCE1?`. The Calibrator responds by sending a decimal number that represents bits 0 through 15. Every time you read the ISCR0 or 1, its contents are zeroed.

Output Queue

The output queue is loaded whenever a query is processed, and holds up to 800 characters. The controller reads it with a statement such as a BASIC INPUT statement, removing what it reads from the queue. If the queue is empty, the Calibrator does not respond to the INPUT statement from the controller. The Message Available (MAV) bit in the Serial Poll Status Byte is 1 if there is something in the output queue and 0 if the output queue is empty.

Error Queue

When a command error, execution error, or device-dependent error occurs, its error code is placed in the error queue where it can be read by the `ERR?` command. (See Appendix C for a list of error messages.) A way to decode an error code is to send the command, `EXPLAIN?`, which returns a description of a error code. Reading the first error with the `ERR?` command removes that error from the queue. A response of 0 means the error queue is empty. The Error Available (EAV) bit in the Serial Poll Status Byte indicates whether the queue is empty. The error queue is cleared when you turn off the power, and when you use the `*CLS` (Clear Status) common command.

The error queue contains up to 16 entries. If many errors occur, only the first 15 errors are kept in the queue. A 16th entry in the queue is always an "error queue overflow" error, and all later errors are discarded until the queue is at least partially read. The first errors are kept, because if many errors occur before the user can acknowledge and read them, the earliest errors are the most likely to point to the problem. The later errors are usually repetitions or consequences of the original problem.

Input Buffer Operation

As the Calibrator receives each data byte from the controller, it places the byte in a portion of memory called the input buffer. The input buffer holds up to 350 data bytes and operates in a first-in, first-out fashion.

RS-232 Under RS-232 serial port remote control using `^S (<Cntl> S)` XOFF protocol, the Calibrator issues a `^S XOFF` when the input buffer becomes 80% full. The calibrator issues a `^Q (<Cntl> Q)` when it has read enough of the input buffer so that it is less than 40% full. When using RTS (Request to Send) protocol (selected as part of the "RS-232 Host Port Setup Procedure"), the serial interface asserts and unasserts RTS in response to same conditions as for XON/XOFF protocol.

Chapter 6

Remote Commands

	Title	Page
Introduction.....		6-3
Command Summary by Function		6-3
Command Details		6-7

Introduction

This chapter documents the remote commands for the 5080A Calibrator (hereafter referred to as “the Calibrator”). Remote commands duplicate activities that can be initiated from the front panel in local operation. Following the summary table is a complete alphabetical listing of all commands, complete with protocol details. Separate headings in the alphabetical listing provide the parameters and responses, plus an example for each command. For information on using commands, see Chapter 5, “Remote Operation.”

Command Summary by Function

Tables 6-1 through 6-7 summarize the commands implemented in the Calibrator.

Table 6-1. Common Command Summary

Command	Description
*CLS	(Clear status.) Clears the ESR, ISCR0, ISCR1, the error queue, and the MSS bit in the status byte. This command terminates pending operation complete commands (*OPC or *OPC?).
*ESE	Loads a byte into the Event Status Enable register.
*ESE?	Returns the contents of the Event Status Enable register.
*ESR?	Returns the contents of the Event Status Register and clears the register.
*IDN?	Identification query. Returns instrument model number, serial number, and firmware revision levels for the main and front-panel CPUs, and inguard FPGA.
*OPC	Enables setting of bit 0 (OPC for "Operation Complete") in the Event Status Register to 1 when all pending device operations are complete.
*OPC?	Returns a 1 after all pending operations are complete. This commands causes program execution to pause until all operations are complete. (See also *WAI.)
*OPT?	Returns a list of the installed hardware and software options.
*PUD	Protected user data command. This command allows you to store a string of bytes in nonvolatile memory. This command works only when the CALIBRATION switch is in the ENABLE position.
*PUD?	Returns the contents of the *PUD (Protected User Data) memory.
*RST	Resets the state of the instrument to the power-up state. This command holds off execution of subsequent commands until it is complete. (Overlapped command.)
*SRE	Loads a byte into the Service Request Enable register (SRE).
*SRE?	Returns the byte from the Service Request Enable register.
*STB?	Returns the status byte.
*TST?	Initiates a series of self-tests, then returns a "0" for pass or a "1" for fail. If any faults are detected, they are logged into the fault queue where they can be read by the ERR? query.
*WAI	Prevents further remote commands from being executed until all previous remote commands have been executed.

Table 6-2. Error Mode Command Summary

Command	Description
EDIT	Sets the edit field. PRI is specified for the output value in single output functions and the primary output value in dual output functions.
EDIT?	Returns the edit field setting.
ERR_UNIT	Chooses how UUT error is shown.
ERR_UNIT?	Returns presently selected value of ERR_UNIT.
INCR	Increments or decrements the output (as selected by the edit field) and enters error mode, the same as using the output adjustment knob in local operation.
MULT	Multiplies the reference magnitude (as selected by the edit field).
NEWREF	Sets the reference value to be the present Calibrator output value, the same as pressing the NEW REF key in local operation.
OLDREF	Sets the Calibrator output to the previously programmed reference value, the same as pressing the ENTER key in local operation.
OUT_ERR?	Returns the UUT error computed after shifting the output with the INCR command.
REFOUT?	Returns the value of the reference, which is the output values of the Calibrator the last time a new reference was established with an OUT, NEWREF, or MULT.

Table 6-3. External Connection Command Summary

Command	Description
CUR_POST	Selects the active binding posts for current output. This applies to current and power outputs.
CUR_POST?	Returns the active binding posts for current output.
EARTH	Connects or disconnects the internal guard shield from earth (chassis) ground.
EARTH?	Returns whether the internal guard shield is connected or disconnected from earth (chassis) ground.
LOWS?	Returns whether or not the low terminals are internally open or tied together.
LOWS	Selects whether or not the low terminals are internally open or tied together for dual outputs.

Table 6-4. Output Command Summary

Command	Description
DBMZ	Sets the impedance used for dBm outputs (ac volts).
DBMZ?	Returns the impedance used for dBm outputs (ac volts).
DPF	Sets the displacement power factor (phase angle) between the NORMAL and AUX terminals for ac power output only.
DPF?	Returns the displacement power factor (phase angle) between the NORMAL and AUX terminals.
FUNC?	Returns the present output, measurement, or calibration function.
LCOMP	Activates or deactivates inductive load compensation for ac current output.

Table 6-4. Output Command Summary (cont.)

Command	Description
LCOMP?	Returns whether inductive load compensation for ac current output is active.
OPER	Activates the Calibrator output if it is in standby.
OPER?	Returns the operate/standby setting.
OUT	Sets the output of the Calibrator and establishes a new reference point for the error mode.
OUT?	Returns the output amplitudes and frequency of the Calibrator.
PHASE	Sets the phase difference between the NORMAL and AUX terminals for dual outputs. The NORMAL terminal output is the phase reference.
PHASE?	Returns the phase difference between the NORMAL and AUX terminals.
POWER?	Returns the equivalent power for dc and ac power output.
RANGE?	Returns the present output ranges.
RANGELCK	Locks in the present range, or selects auto ranging.
RANGELCK?	Returns whether or not the preset output range is locked.
STBY	Puts the Calibrator in standby.
ZCOMP	Activates (2-wire or 4-wire) or deactivates impedance compensation.
ZCOMP?	Returns whether or not impedance compensation is active and, if active, which type.

Table 6-5. RS-232 Host Port Command Summary

Command	Description
LOCAL	Puts the Calibrator into the local state.
LOCKOUT	Puts the Calibrator into the lockout state. This command duplicates the IEEE-488 LLO (Local Lockout) message.
REMOTE	Puts the Calibrator into the remote state. This command duplicates the IEEE-488 REN (Remote Enable) message.
SPLSTR	Sets the serial remote mode Serial Poll response string.
SPLSTR?	Returns the string programmed for serial remote mode Serial Poll responses.
SRQSTR	Sets the serial remote mode SRQ (Service Request) response (up to 40 characters).
SRQSTR?	Returns the string programmed for Serial Mode SRQ response.
^P (<cntl>p)	Control-P character prints the serial poll string. (See SPLSTR for string format.)
^C (<cntl>c)	Control-C character clears the device.

Table 6-6. Setup and Utility Command Summary

Command	Description
CLOCK	Sets the real-time clock.
CLOCK?	Queries the real-time clock.
DBMZ_D	Sets the power-up and reset default impedance used for dBm outputs (ac volts).
DBMZ_D?	Returns the power-up and reset default impedance used for dBm outputs (ac volts).
DHCP	Enable/disable LAN DHCP setting.
DHCP?	Return the LAN DHCP state.
FORMAT	Use with extreme care. Restores the contents of the nonvolatile memory device to factory defaults.
FULLHOSTNAME?	Returns the fully qualified domain name.
GWADDR	Sets the LAN gateway IP address.
GWADDR?	Returns the LAN gateway IP address.
HOSTNAME	Sets the LAN hostname.
HOSTNAME?	Returns the LAN hostname.
IPADDR	Sets the static LAN IP address.
IPADDR?	Returns the LAN IP address (either static or dynamic).
IPPORT	Sets the LAN IP port number.
IPPORT?	Returns the LAN IP port number.
LANGUAGE	Sets the language for the control display (right display) on the front panel.
LANGUAGE?	Returns the display language setting for the control display.
LIMIT	Sets the maximum permissible output magnitudes, negative and positive.
LIMIT?	Returns the programmed output magnitude limits for voltage and current.
MACADDR?	Returns the MAC address.
MAINS50HZ	Optimize internal A/D for 50 Hz or 60 Hz power operation.
MAINS50HZ?	Returns the internal A/D 50/60 Hz mains power setting.
PR_RPT	Prints the Stored, Active or CAL-Constant CAL_Report through the Serial Port.
SP_SET	Sets the HOST serial port communication parameters and saves them in nonvolatile memory.

Table 6-6. Setup and Utility Command Summary (cont.)

Command	Description
SP_SET?	Returns the HOST serial port communication parameters contained in nonvolatile memory.
SUBNETMASK	Sets the LAN subnet IP mask.
SUBNETMASK?	Returns the LAN subnet IP mask.
UNCERT?	Returns specified uncertainties for the present output. If there are no specifications for an output, returns zero.

Table 6-7. Status Command Summary

Command	Description
ERR?	Returns the first error code with an explanation contained in the Calibrator error queue, then removes that error code from the queue.
EXPLAIN?	Explains an error code. This command returns a string that explains the error code furnished as the parameter.
FAULT?	Returns the first error code contained in the Calibrator error queue, then removes that error from the queue.
FUNC?	Returns the present output, measurement, or calibration function.
ISCE	Loads two bytes into both the Instrument Status 1 to 0 Change Enable register and the Instrument Status 0 to 1 Change Enable register.
ISCE?	Returns the OR of the contents of the Instrument Status 1 to 0 Change Enable register and the Instrument Status 0 to 1 Change Enable register.
ISCE0	Loads two bytes into the Instrument Status 1 to 0 Change Enable register.
ISCE0?	Returns the contents of the Instrument Status 1 to 0 Change Enable register.
ISCE1	Loads two bytes into the Instrument Status 0 to 1 Change Enable register.
ISCE1?	Returns the contents of the Instrument Status 0 to 1 Change Enable register.
ISCR?	Returns the OR of the contents of the Instrument Status 1 to 0 Change Register and the Instrument Status 0 to 1 Change Register and clears both registers.
ISCR0?	Returns and clears the contents of the Instrument Status 1 to 0 Change Register.
ISCR1?	Returns and clears the contents of the Instrument Status 0 to 1 Change Register.
ISR?	Returns the contents of the Instrument Status Register.
ONTIME?	Returns the time since the Calibrator was powered up last.

Command Details

All commands recognized by the Calibrator are listed in alphabetical order in the following sections along with description and syntax rules. Each command fall into one or more command categories: Sequential, Overlapped, and Coupled.

Sequential Commands – Commands executed immediately as they are encountered in the data stream are called sequential commands. For more information, see “Sequential Commands” in Chapter 5.

Overlapped Commands – Commands that require additional time to execute are called overlapped commands because they can overlap the next command before completing execution. To be sure an overlapped command is not interrupted during execution, use the *OPC, *OPC?, and *WAI commands to detect command completion. See Table 6-8 for all the commands that are classified as overlapped. For more information, see “Overlapped Commands” in Chapter 5.

Coupled Commands – These are called coupled commands (examples: CUR_POST and OUT) because they “couple” in a compound command sequence. Care must be taken to be sure the action of one command does not disable the action of a second command and thereby cause a fault. See Table 6-8 for all the commands that are classified as coupled. For more information, see “Coupled Commands” in Chapter 5.

Table 6-8. Overlapped and Coupled Commands

Command	Overlapped	Coupled
CUR_POST	Yes	Yes
DBMZ	Yes	Yes
DPF	Yes	No
EARTH	Yes	No
INCR	Yes	No
LCOMP	Yes	No
LOWS	Yes	No
MULT	Yes	No
OLDREF	Yes	No
OPER	Yes	No
OUT	Yes	Yes
PHASE	Yes	No
RANGELCK	Yes	No
*RST	Yes	No
STBY	Yes	No
ZCOMP	Yes	No

CLOCK(?) <value >

Description Sets the real time clock, time only, or date and time. To set the date, the CALIBRATION switch must be in the ENABLE position.

Parameters <value> =

1. (optional) year in the format YYYY
2. (optional) month in the format MM
3. (optional) day in the format DD
4. hour in the format HH
5. minute in the format MM
6. second in the format SS

Examples CLOCK 1998,6,1,9,52,10 Sets the clock to June 1, 1998, 9:52:10 AM

	CLOCK 13,10,10	Sets the clock time to 1:10:10 PM
Query	CLOCK?	Retrieves clock data: 1998-12-04,13:03:50.

***CLS**

Description Clears the ESR, ISCR0, ISCR1, the error queue, and the MSS bit in the status byte. This command terminates pending operation complete commands (*OPC or *OPC?).

Examples *CLS Clear the ESR, ISCR0, ISCR1, the error queue, and the MSS bit in the status byte.

CUR_POST(?) <value >

Description Selects the binding posts for current output. This also applies to power outputs. The current post setting is retained until the power is turned off or the button is pressed.

Parameters <value> = AUX AUX terminals
A20 20A terminals

Example CUR_POST AUX Sets the AUX terminals for current output.

Query CUR_POST? Retrieves the front-panel post being used for current output.

DBMZ(?) <value >

Description Sets the impedance used for dBm outputs (ac volts).

Parameters <value> = Z50 50 ohms
Z75 75 ohms
Z90 90 ohms
Z100 100 ohms
Z135 135 ohms
Z150 150 ohms
Z300 300 ohms
Z600 600 ohms
Z900 900 ohms
Z1000 1000 ohms
Z1200 1200 ohms

Example DBMZ Z600 Sets the impedance for dBm outputs to 600 ohms.

Query DBMZ? Retrieves the impedance for dBm outputs.

DBMZ_D(?) <value >

Description Sets the power-up and reset default impedance used for dBm outputs (ac volts).

Parameters <value> = Z50 50 ohms
Z75 75 ohms
Z90 90 ohms
Z100 100 ohms
Z135 135 ohms
Z150 150 ohms
Z300 300 ohms
Z600 600 ohms
Z900 900 ohms
Z1000 1000 ohms

	Z1200	1200 ohms
Example	DBMZ_D Z90	Sets the power-up and reset default impedance for dBm outputs to 90 ohms.
Query	DBMZ_D?	Retrieves the power-up and reset defaults impedance for dBm outputs.

DHCP(?) *[[ON|OFF]]*

Description	Enables/disables Dynamic Host Configuration Protocol (DHCP) operation. Stores the setting in non-volatile memory. With the DHCP enabled, the IP address will be assigned by the DHCP server. The Calibrator can then be accessed by the IP address assigned by the DHCP server or by the hostname.domainname assigned by the server. When using DHCP, the default gateway IP address and subnet mask are automatically assigned.	
Parameters	OFF	Disables Dynamic Host Configuration Protocol.
	ON	Enables Dynamic Host Configuration Protocol.
Example	DHCP? OFF	Disables Dynamic Host Configuration Protocol.
Query	DHCP?	Returns whether or not the Calibrator NORMAL LO terminal is tied to chassis (earth) ground.
Response	<boolean>	DHCP setting.

DPF(?) *<n>, <value >*

Description	Sets the displacement power factor (phase angle) between the Calibrator front-panel terminals NORMAL and AUX. The NORMAL terminal output is the phase reference. The phase offset is expressed as the cosine of the phase offset (0.000 to 1.000) and a LEAD (default) or LAG term, which determines whether the AUX output leads or lags the NORMAL output.	
Parameters	<.nnn> = 0 to 1	The cosine of the phase offset.
	<value> = LEAD	AUX output leads the NORMAL output.
	LAG	AUX output lags the NORMAL output.
Example	DPF .123, LEAD	Set the current output on the Calibrator AUX terminals to lead the voltage output on the NORMAL terminals by 82.93 degrees. (Cosine of 82.93 degrees is 0.123, nominal.)
Query	DPF?	Returns the displacement power factor (cosine of the phase angle) between the Calibrator front-panel NORMAL and AUX terminals for sine wave outputs. The return is 0 if power factor does not apply to the output.

EARTH(?) *<value >*

Description	Selects whether or not the Calibrator front-panel NORMAL LO terminal is tied to chassis (earth) ground. Once set, the Calibrator retains the earth setting until power off or reset.	
Parameters	<value> = OPEN	Disconnect LO terminal from chassis ground.
	TIED	Connect LO terminal to chassis ground.
Example	EARTH TIED	Tie the Calibrator the NORMAL LO terminal to earth (the front-panel  key annunciator is on
Query	EARTH?	Returns whether or not the Calibrator NORMAL LO terminal is tied to chassis (earth) ground.

EDIT(?) <value >

Description	Sets the edit field to the primary, secondary or frequency field.	
Parameters	<value> =	
	PRI	Edit the value in single output functions and the primary output value in dual output functions.
	SEC	Edit the secondary value in dual output functions.
	FREQ	Edit the frequency value in single ac output functions.
	OFF	Edit is off, which is the same as using the NEWREF command.
Example	EDIT FREQ	Load FREQ into the edit field to edit frequency.
Query	EDIT?	Returns the edit field setting. Returns OFF when no value is in edit.

ERR?

Description	Returns the first error code contained in the Calibrator error queue, then removes that error code from the queue. Following the error code is an explanation of the error code, similar to but sometimes containing more specific information than the EXPLAIN? command. The explanation sent in response to this query can contain variables specific to a particular error event. See Appendix C for a list of error codes and error messages.	
	A zero value is returned when the error queue is empty. To read the entire contents of the error queue, repeat ERR? until the response 0, "No Error" is returned. For terminal users, the error queue Returns for ERR? is always 0, "No Error" because error messages are returned instead of queued.	
Response	<value>, <string>	<value> = error code value. <string> = test string explaining the error.
Example	ERR?	Returns 0, "No Error" when the error queue is empty.

ERR_UNIT(?) <value >

Description	UUT Error Unit Thresh Hold command chooses how UUT error is shown (this is nonvolatile).	
Parameters	<value> =	
	GT1000	UUT error is displayed in % above 1000 ppm, ppm below.
	GT100	UUT error is displayed in % above 100 ppm, ppm below.
	GT10	UUT error is displayed in % above 10 ppm, ppm below.
	PPM	UUT error displayed in ppm always.
	PCT	UUT error displayed in % always.
Example	ERR_UNIT GT10	Set to display UUT error in % above 10 ppm.
Query	ERR_UNIT?	Returns presently selected values of ERR_UNIT.

***ESE(?) <value >**

Description	Event Status Enable command loads a byte into the Event Status Enable (ESE) register. (See "Event Status Enable Register (ESE)" in Chapter 5).	
Parameters	<value> =	0 to 255 Decimal equivalent of the ESE byte.

Example *ESE 140 Load decimal 140 (binary 10001100) to enable bits 7 (PON), 3 (DDE), and 2 (QYE).

Query *ESE? Returns the contents of the Event Status Enable (ESE) register.

***ESR?**

Description Event Status Register query returns the contents of the Event Status Register (ESR) and clears the register. (See “Event Status Register (ESR)” in Chapter 5).

Response <value> = 0 to 255 Decimal equivalent of the ESE byte.

Query *ESR? Returns the contents of the Event Status Register (ESR).

EXPLAIN? <value>

Description Explain Error query explains an error code. This command returns a string that explains the error code furnished as the parameter. The error code (same as the parameter) is originally obtained by sending the FAULT? query. (See the ERR? command, which returns both the error code and the explanation string.) See Appendix C for a list of error codes and error messages.

Parameters <value> = 0 to 255 Error code in question.

Response <string> Explanation of the error code, with the parameter (if there is one) shown as a percent sign followed by d (integer parameter), f (floating point parameter), or s (string parameter).

Query EXPLAIN? 539 Returns “Can’t change compensation now.”

FAULT?

Description Fault query returns the first error code contained in the Calibrator error queue, then remove that error from the queue. After obtaining the error code, use the EXPLAIN? command to view an explanation. A zero value is returned when the error queue is empty. To read the entire contents of the error queue, repeat FAULT? until the response is 0. (Only system errors appear in the error queue.)

Response <value> = 0 to 255 Error code value.

Query FAULT?

To view an explanation of the error, enter the command EXPLAIN? <error code>.

FORMAT <value >

Description **Use with extreme care.** Format command restores the contents of the nonvolatile memory device to factory defaults. The memory holds calibration constants and setup parameters. You lose all calibration data permanently. The CALIBRATION switch on the rear panel of the Calibrator must be set in the ENABLE position or an execution error occurs, except for FORMAT SETUP.

Parameters <value> = ALL Replaces the whole contents with factory defaults.
CAL Replaces all cal constants with factory defaults.
SETUP Replaces setup parameters with factory defaults.

Example FORMAT SETUP Replace the setup parameters with the default setup values. See Table 6-9.

The FORMAT ALL command is the same as FORMAT CAL and then FORMAT

SETUP.) The FORMAT SETUP command also clears the *PUD string (see the *PUD command) and SRQSTR is set to “SRQ: %02x %02x %04x %04x” (see the SRQSTR command) and SPLSTR is set to “SPL: %02x %02x %04x %04x” (see the SPLSTR command).

Table 6-9. Default Setup Values

Features			
		Display Contrast ^[1]	3,7
Host Connection	Serial	Display brightness ^[1]	1,2
Serial Ports	8 bits, 1 stop bit, xon/xoff, parity none, 9600 baud		
EOL (end of line)	CRLF	Current Limits	±20.5 A
EOF (end of file)	012,000	Voltage Limits	±1020 V
Remote I/F	comp		
Remote commands (see Chapter 6)			
SRQSTR	SRQ: %02x %02x %04x %04x	*PUD string	cleared
Defaults			
dBm Impedance	600 Ω		
[1] Output Display and Control Display, respectively. There are 8 levels: 0,1,2,3,4,5,6,7.			

FULLHOSTNAME?

Description Get the hostname.domainname of the Calibrator. When the DHCP server allocates a dynamic IP address, it associates it with the entered hostname and the domain that the host resides on. The FULLHOSTNAME command will return the hostname.domainname from the DNS server (e.g. if hostname is FLUKE1 and the DHCP server is on the na.flukecorp.com domain, FLUKE1.na.flukecorp.con will be returned by the DNS server).

Response <string> Fully qualified hostname.

FUNC?

Description (Function query) Returns the present output, measurement, or calibration function. See the response below for output & measurement modes.

Response

DCV	DC volts function.
ACV	AC volts function
DCI	DC current function
ACI	AC current function
RES	Ohms function
DC_POWER	DC power function
AC_POWER	AC power function
DCV_DCV	Dual dc volts function
ACV_ACV	Dual ac volts function

Example FUNC?

GWADDR(?) <string>

Description Sets the default Ethernet static gateway IP address. Stores the setting in non-volatile memory. The static default gateway address must be entered as a quoted string in the form of “XXX.XXX.XXX.XXX”. A limited attempt to verify that the address is valid (i.e. in the correct format) is

performed. The static default gateway address will be used if DHCP (Dynamic Host Configuration Protocol) is disabled and will be applied the next time the unit is power cycled. If DHCP is enabled, the subnet mask is automatically set by the DHCP server.

Parameters	<string>	Default gateway address.
Example	GWADDR "129.196.136.1"	
Query	GWADDR?	Returns the default gateway address.

HOSTNAME(?) <string>

Description Sets the hostname for DHCP operation. Stores the setting in non-volatile memory. Hostname must be entered as a quoted string (e.g. "FLUKE1"). The DHCP server will allocate an IP address and associates that IP address with the hostname when it registers with the DNS (Domain Name Server) lookup table. The string length is limited to 40 characters.

Parameters	<string>	Default gateway address.
Example	HOSTNAME "FLUKE1"	
Query	HOSTNAME?	Returns the hostname for DHCP operation.

*IDN?

Description Identification query returns instrument model number, serial number, and firmware revision levels for the main, encoder, and inguard CPUs.

Response <Indefinite ASCII> A message containing four fields separated by commas as follows:

1. Manufacturer
2. Model number
3. Serial number
4. Firmware revision levels for the Main CPU+Front-panel CPU+Inguaud FPGA

Example *IDN? Returns
FLUKE, 5080A, 5248000, 1.2+1.3+1.3.

Actual revision numbers may be different than those shown in this example.

INCR

Description Increments or decrements the output (as selected using the EDIT command, or defaults to the primary output) and enters error mode; the same as using the Calibrator output adjustment knob in local operation.

Parameters	<+value> = Increment value. Optional unit matching edit field. <-value> Decrement value.	
Example	INCR +.00001	Load the error mode and increment the selected edit field by .00001 mV.

IPADDR(?) <string>

Description Sets the Ethernet Static IP address. Stores the setting in non-volatile memory. The Static IP Address must be entered as a quoted string in the form of "XXX.XXX.XXX.XXX". A limited attempt to verify that the address is valid (i.e. in the correct format) is performed. Static IP address will be used if DHCP (Dynamic Host Configuration Protocol) is disabled and will be applied the next time the Calibrator is power cycled. When addressing some LAN addresses, computers will often interpret 0's in the IP address as OCTAL values. As an example, if you configure your IP

address as 129.196.017.023 it maybe interpreted by some computers as 129.196.15.19 (its decimal equivalent). When entering ip addresses, remove leading zeros to remove any potential confusion.

- Parameters** <string> IP address.
- Example** IPADDR "129.196.137.118"
- Query** IPADDR? Returns the Ethernet IP address.

This command will return the setting of the Ethernet IP address. Note, if you have changed the IP address using the IPADDR command but have not power cycled the unit (the IP address hasn't been set yet) the returned IP address will be that which the unit will be set to on the next power cycle.

IPPORT(?) <value>

- Description** Sets the Ethernet port number. Stores the setting in non-volatile memory.
- Parameters** <value> = 1024 to 65535 Ethernet port number.
- Example** IPPORT 3490
- Query** IPPORT? Returns the Ethernet port number.

ISCE(?) <value>

- Description** Instrument Status Change Enable command loads two bytes into the two 16-bit ISCE mask registers (ISCE1 and ISCE0). (See "Instrument Status Change Enable Registers" in Chapter 5 for more information.)
- Parameters** <value> = 0 to 32767 Decimal equivalent of the 16 bits.
- Example** ISCE 6272 Load decimal 6272 (binary 0001010001000000) to enable bits 12 (SETTLED), 10 (REMOTE) and 6 (HIVOLT). This is equivalent to sending the commands ISCE0 6272 and ISCE1 6272.
- Query** ISCE? Returns the two bytes from the two 16-bit ISCE mask registers (ISCE1 and ISCE0) logically OR'ed together.

ISCE0(?) <value>

- Description** Instrument Status 1 to 0 Change Enable command loads two bytes into the 16-bit ISCE0 register. (See "Instrument Status Change Enable Registers" in Chapter 5 for more information.)
- Parameters** <value> = 0 to 32767 Decimal equivalent of the 16 bits.
- Example** ISCE0 6272 Load decimal 6272 (binary 0001010001000000) to enable bits 12 (SETTLED), 10 (REMOTE) and 6 (HIVOLT).
- Query** ISCE0? Returns the two bytes from the 16-bit ISCE0 register.

ISCE1(?) <value>

- Description** Instrument Status 0 to 1 Change Enable command loads two bytes into the 16-bit ISCE1 register. (See "Instrument Status Change Enable Registers" in Chapter 5 for more information.)
- Parameters** <value> = 0 to 32767 Decimal equivalent of the 16 bits.

Example	ISCE1 6272	Load decimal 6272 (binary 0001010001000000) to enable bits 12 (SETTLED), 10 (REMOTE) and 6 (HIVOLT).
Query	ISCE1?	Returns the two bytes from the 16-bit ISCE1 register.

ISCR?

Description	Instrument Status Change Register query returns and clears the contents of the Instrument Status 0 to 1 Change Register (ISCR1) and Instrument Status 1 to 0 Change Register (ISCR0). (See “Instrument Status Change Register” in Chapter 5 for more information.)	
Response	<value> = 0 to 32767	Decimal equivalent of the 16 bits.
Example	ISCR?	

ISCR0?

Description	Instrument Status 1 to 0 Change Register query returns and clears the contents of the Instrument Status 1 to 0 Change Register.	
Response	<value> = 0 to 32767	Decimal equivalent of the 16 bits.
Example	ISCR0?	

ISCR1?

Description	Instrument Status 0 to 1 Change Register query returns and clears the contents of the Instrument Status 0 to 1 Change Register.	
Response	<value> = 0 to 32767	Decimal equivalent of the 16 bits.
Example	ISCR1?	

ISR?

Description	Instrument Status Register query. Returns contents of the Instrument Status Register.	
Response	<value> = 0 to 32767	Decimal equivalent of the 16 bits.
Example	ISR?	

LANGUAGE(?) [{ENGLISH|CHINESE}]

Description	Sets the language for the control display (right display) on the front panel and stores the setting in non-volatile memory.	
Parameters	ENGLISH	Sets display language to English.
	CHINESE	Sets display language to Chinese.
Example	LANGUAGE ENGLISH	Sets display language to English.
Query	LANGUAGE?	Returns the language setting for the control display.

LCOMP(?) [{ON|OFF}]

Description	Inductive compensation command activates or deactivates inductive load compensation for ac current output. For current output, compensation is allowed when the frequency is less than 65 Hz.	
Parameters	OFF	Turns off the inductive load compensation circuitry.
	ON	Turns on the inductive load compensation circuitry.
Example	LCOMP ON	Sets inductive load compensation on.

Query LCOMP? Returns whether inductive load compensation for ac current output is active.

LIMIT(?) <value1>, <value2>

Description Sets the maximum permissible output magnitude, negative and positive, for voltage and current, which is saved in the Calibrator non-volatile memory. (While saving configuration data in the non-volatile memory, a period of about 2 seconds, the Calibrator does not respond to remote commands.) Both negative and positive values must be entered. Once set, the Calibrator retains the limit settings until either another limit is entered, or the **FORMAT SETUP** command resets the limits (and all other defaults) to the factory settings (± 1020 V, ± 20.5 A). See the **FORMAT** command.

The magnitude of the limit has the following effect on different waveforms:

dc magnitude of limit
ac (sine wave) magnitude of limit (rms)

Response <value1> Positive value.
<value2> Negative value

Examples **LIMIT 100V, -100V** Limit the voltage output to ± 100 V dc, 100 V ac.
LIMIT 1A, -1A Limit the current output to ± 1 A dc, 1 A ac.

Query **LIMIT?** Returns the programmed output magnitude limits for voltage and current.

Example **LIMIT?** Returns 1020.0000, -1020.0000, 20.5000, -20.5000.

LOCAL

Description Local command puts the Calibrator into the local state, clearing the remote state (see the **REMOTE** command) and front-panel lockout (see the **LOCKOUT** command). This command duplicates the IEEE-488 GTL (Go To Local) message.

Examples **LOCAL** Sets the Calibrator into the local state, clearing the remote state and front-panel lockout (if enabled).

LOCKOUT

Description Lockout command puts the Calibrator into the lockout state when in remote control (see the **REMOTE** command). This means no local operation at the front panel is allowed during remote control. To clear the lockout condition, use the **LOCAL** command. This command duplicates the IEEE-488 LLO (Local Lockout) message.

Examples **LOCKOUT** Set the instrument into the front-panel lockout state. The front-panel controls cannot be used.

LOWS(?) [{OPEN|TIED}]

Description Selects whether or not the Calibrator front-panel **NORMAL LO** terminal and **AUX LO** terminal are internally tied together (default) or are open. This feature is used for ac power, dc power, dual dc volts, and dual ac volts output. Once set, the Calibrator retains the **LO** setting until power off or reset.

Parameters <value> = **OPEN** Disconnect **NORMAL LO** and **AUX LO** terminals.

	TIED	Connect NORMAL LO and AUX LO terminals.
Example	LOWS TIED	Tie the front-panel NORMAL LO and AUX LO terminals together.
Query	LOWS?	Returns whether or not the Calibrator front-panel NORMAL LO terminal and AUX LO terminal are internally tied together (default) or are open.

MACADDR?

Description	Queries the Calibration for the MAC address.	
Response	<string>	Ethernet MAC address.
Example	MACADDR?	

MULT <value >

Description	Multiply command multiplies the reference magnitude (as selected with the EDIT command or default to the primary output). The reference magnitude is the present reference in either direct mode or in error mode.	
Parameters	<value>	Multiplier expressed as a floating point number.
Example	MULT 2.5	Multiply the existing reference by 2.5, creating a new reference. For example, an existing reference of 1 V is multiplied to 2.5 V.

NEWREF

Description	Sets the new reference to the present Calibrator output value and exit the error mode (if selected). For example, you might edit the Calibrator output using the EDIT and INCR commands, and then use the NEWREF command to establish a new reference point and exit the error mode. This is the same as pressing the Calibrator front-panel  key.	
Examples	NEWREF	Set the reference value to the current Calibrator output value.

OLDREF

Description	Sets the Calibrator output to the reference value and exit the error mode (if selected). If editing the output using the EDIT and INCR commands and you want to return to the reference value, use the OLDREF command. If editing the output and you want to make the edited value the new reference, use the NEWREF command.	
Examples	OLDREF	Set the output to the existing reference value, clearing editing changes.

ONTIME?



Description	Calibrator On Time query returns the time in minutes since the Calibrator was most recently powered up.	
Response	<minutes>	
Example	ONTIME?	Returns 47 to indicate 47 minutes since the Calibrator was last powered up.

*OPC(?)

Description	Operations Complete command sets bit 0 (OPC) of the Event Status Register to 1 when all pending device operations are complete. Also see the *ESR? command.	
--------------------	---	--

Example	*OPC	Set bit 0 of the Event Status Register to 1 when all pending device operations are done.
Query	*OPC?	Returns a 1 after all pending operations are complete. This command causes program execution to pause until operations are complete. (See *WAI.)

OPER(?)

Description	Activates the Calibrator output if it is in standby. This is the same as pressing the Calibrator front-panel  key. If there are errors in the error queue, the OPER command is inhibited for outputs 33 V and over. (Also see the ERR? command and STBY command.)	
Example	OPER	Connect the selected output to the Calibrator front-panel terminals. Also lights the annunciator in the  key.
Query	OPER?	Returns 1 when the Calibrator is in operate.

***OPT?**

Description	Returns a list of the installed hardware and software options.	
Response	<option>, <option> ...	Options list separated by commas. Returns 0 when no options are installed.

OUT(?) <value>

Description	Sets the output of the Calibrator and establishes a new reference point for the error mode. If only one amplitude is supplied, the Calibrator sources a single output. If two amplitudes are supplied, the Calibrator sources two outputs. The second amplitude will be sourced at the AUX terminals for dual voltage outputs. If the frequency is not supplied, the Calibrator will use the frequency that is presently in use. Use multipliers e.g., k, M, μ with the OUT command, as desired.	
--------------------	---	--

Parameters	<value> =	<n> V Volts dc or update volts ac <n> DBM Volts ac dBm update <n> V, <n> HZ Volts ac or volts dc with 0 Hz <n> DBM, <n> HZ Volts ac in dBm <n> A Current dc or update current ac <n> A, <n> HZ Current ac <n> OHM Resistance <n> HZ Update frequency <n> V, <n> A Power dc or update power ac <n> V, <n> A, <n> HZ Power ac <n> V, <n> V Dual volts dc or update dual ac <n> V, <n> V, <n> HZ Dual volts ac in volts <n> For single output, changes amplitude keeping unit and frequency the same
-------------------	-----------	---

Examples	OUT 15.2 V	Volts; 15.2 V @ same frequency.
	OUT 20 DBM	Volts; 20 dBm @ same frequency
	OUT 10 V, 60 HZ	Volts ac; 10 V @ 60 Hz
	OUT 10 DBM, 50 Hz	Volts ac; 10 dBm @ 50 Hz
	OUT 1.2 MA	Current; 1.2 mA @ same frequency
	OUT 1 A, 400 HZ	Current ac; 1 A @ 400 Hz
	OUT 1 KOHM	Ohms; 1 k Ω

OUT 60 HZ	Frequency update; 60 Hz
OUT 10 V, 1 A	Power; 10 watts @ same frequency
OUT 1 V, 1 A, 60 HZ	Power ac; 1 watts @ 60 Hz
OUT 1 V, 2 V	Dual volts; 1 V, 2 V @ same frequency
OUT 10 MV, 20 MV, 60 HZ	Dual volts; .01 V, .02 V @ 60 Hz

Each example shows a value and unit, e.g., -15.2 V. If a value is entered without a unit, the value of the existing output is changed, when logically allowed.

Query OUT? Returns the output amplitudes and frequency of the Calibrator. Multipliers (e.g., K or M) are not used in the response.

Examples OUT? Returns -1.520000E+01, V, 0E+00, 0, 0.00E+00
 OUT? Returns 1.88300E-01, A, 0E+00, 0, 4.420E+02
 OUT? Returns 1.23000E+00, V, 2.34000E+00, V, 6.000E+01
 OUT? Returns 1.92400E+06, OHM, 0E+00, 0, 0.00E+00
 OUT? Returns 1.52000E+01, V, 1.88300E-01, A, 4.420E+02
 OUT? DBM Returns 2.586E+01, DBM, 0E+00, A, 4.420E+02

The respective values for the above examples are:

-15.2 V
 188.3 mA, 442 Hz
 1.23 V, 2.34 V, 60 Hz
 1.924 MΩ
 15.2 V, 188.3 mA, 442 Hz
 25.86 dBm, 442 Hz (25.86 dBm = 15.2 at 600 Ω)

The primary and secondary units are: V, DBM, A, OHM. The units for the <frequency value> is always assumed to be Hz.

OUT_ERR?

Description Returns the UUT error and units computed by the Calibrator after shifting the output with the INCR command. The return units are PPM (parts per million), PCT (percent), DB (decibels) or 0 if there is no error. The UUT error is not computed when editing frequency.

Response <value of error>, <units>

Example OUT_ERR? Returns -1.00000E+01, PCT.

PHASE(?) <value>

Description Sets a phase difference between the Calibrator front-panel NORMAL and AUX or 20A terminals for ac power and ac dual voltage outputs. The NORMAL terminal output is the phase reference. The set range is 0.00 to ±180.00 degrees, with + for a leading phase difference and - for a lagging phase difference.

Parameters <value> DEG 0.00 to ±180.00 (DEG, for degree is optional).

Example PHASE -60 DEG Set the phase difference so the frequency output at the AUX terminals lags the frequency output at the NORMAL terminals by 60 degrees.

Query PHASE? Returns the phase difference between the Calibrator front-panel NORMAL and AUX terminals for ac power and ac dual voltage outputs.

Example PHASE? Returns -6.000E+01. Returns -60 when the frequency output at the AUX terminals is

lagging the frequency output at the NORMAL terminals by 60 degrees.

POWER?

Description Returns the equivalent real power for ac and dc power outputs, based on the voltage and current settings, and power factor (ac only). If the output is not ac or dc power, the return is 0E+00 (zero) watts.

Example POWER? Returns 1.00000E+01

Returns 10 when the output voltage is 10 V dc and output current is 1 A dc, for 10 watts real power. Or returns 10 when the output voltage is 10 V ac and output current is 2 A ac and power factor is 0.5 for 10 watts real power.

PR_PRT

Description Prints a self calibration report out the RS-232 Host serial port.

Parameters 1. Type of report to print: **STORED**, **ACTIVE**, or **CONTS**
2. Format of report: **PRINTED** (designed to be read), **SPREAD** (designed to be loaded into a spreadsheet)
3. Calibration interval to be used for instrument specifications in the report:

Example PR_PRT STORED, PRINT, I90D

***PUD? <text>**

Description Stores a string of 64 characters (maximum), which is saved in the 5080A non-volatile memory. (While saving configuration data in the non-volatile memory, a period of about 2 seconds, the 5080A does not respond to remote commands.) This command works only when the CALIBRATION switch on the rear panel of the Calibrator is in the ENABLE position. Include a line feed (RS-232) character to terminate the block data.

Parameters #2<nn><character string> (definite length)
#0<character string> (indefinite length)
“<character string>” (character string)
‘<character string>’ (character string)

Example *PUD #0CAL LAB NUMBER 1

Store the string CAL LAB NUMBER 1 in the protected user data area using the indefinite length format.

Example *PUD #216CAL LAB NUMBER 1

Store the string CAL LAB NUMBER 1 in the protected user data area using the definite length format, where #2 means two digits follow which represent the number of text characters nn in CAL LAB NUMBER 1 (including spaces=16).

Example *PUD “6CAL LAB NUMBER 1”

Store the string CAL LAB NUMBER 1 in the protected user data area using the character string format.

Query *PUD? Returns the contents of the *PUD (Protected User Data) memory in definite length format.

Example *PUD? Returns #216CAL LAB NUMBER

Returns #2 then 16 then 16 characters of text (including spaces) stored in the nonvolatile memory.

RANGE?

Description Returns the present output ranges. Both the primary output and secondary outputs are returned. If there is no secondary output, 0 is returned. Dual outputs are noted with P for primary output (front-panel NORMAL terminals) and S for secondary output (front-panel AUX terminals).

Response <primary output>, <secondary output>

Examples	DC330MV, 0	DC volts 330 mV range
	DC330MA A, 0	DC current 33 mA range
	AC3 3V, 0	AC volts 3.3 V range
	AC330MA A, 0	AC current 330 mA range
	R1 0K0HM, 0	Ohms 1 kΩ range
	DC3 3V P, DC3A AS	DC power 3.3 V, 3 A ranges
	AC330V P, AC20A 2S	AC power 330 V, 20 A ranges
	DC330MV P, DC3 3V S	Dual dc volts 330 mV, 3.3 V ranges
	AC330V P, AC3 3V S	Dual ac volts 330 V, 3.3 V ranges

Returns the symbolic name of the single or first output, and return the symbolic name of the second output (0 if there is no second output).

RANGELCK(?) [{ON|OFF}]

Description Locks in the present range, or selects auto ranging for dc voltage and dc current single outputs. The range automatically unlocks if the output function changes, for example from dc volts to dc current. When RANGELCK is on, this is equivalent to the softkey range lock showing locked. When RANGELCK is off, this is equivalent to the softkey range lock showing auto.

Parameters ON Locks the dc volts or dc current range.
OFF Unlocks the dc volts or dc current range for autoranging.

Example RANGELCK OFF Allows autoranging for dc volts and dc current.

Query RANGELCK? Returns ON or OFF. Returns OFF when the range for dc volts or dc current is not locked (autoranging enabled).

REFOUT?

Description Returns the present value of the reference when editing the output (error mode). If not editing the output using the INCR command, the return is 0E+00. The reference value is set with the OUT, NEWREF or MULT commands. To determine which quantity is being edited, use the EDIT? and OUT? commands.

Response <reference value>

Examples REFOUT? Returns 0E+00 when the output is not being edited. Returns 2.500000E-01 for .250 when the output is being edited and the reference is, for example, 250 mV.

REMOTE

Description Places the Calibrator into the remote state. This command duplicates the IEEE-488 REN (Remote Enable) message. When in the remote state, the Control Display shows the softkey “REMOTE CONTROL Go to Local.” Pressing this softkey returns the Calibrator to local operation. If the front panel is locked out, the Control Display shows the softkey “REMOTE CONTROL LOCAL LOCK OUT.” (See the LOCKOUT command.) To

unlock the front panel, use the LOCAL command, or cycle the Calibrator power switch.

Parameters None

Example REMOTE

RPT_STR(?)

Description Loads the user report string. The user report string can be read on the Control Display in local operation, and appears on calibration reports. The CALIBRATION switch must be set to ENABLE. (Sequential command.)

Parameters String of up to 40 characters.

Query RPT_STR? Returns the user report string. Up to 40 characters.

***RST**

Description Resets the Calibrator to the power-up state. *RST holds off execution of subsequent commands until the reset operation is complete. This command is the same as pressing the front-panel  key.

A reset command evokes the following commands and values:

Command	Value
CUR_POST	AUX
DBMZ	<DBMZ_D value>
EARTH	OPEN
LCOMP	OFF
LOWS	TIED
OUT	0V, 0HZ
OUT_IMP	Z1M
PHASE	0DEG
RANGELCK	OFF
STBY	(No output)
ZCOMP	OFF

Changes made to the setup menus that are not saved in memory are discarded on reset.

Parameters None.

Example *RST Places the Calibrator in a reset condition, evoking the commands and values shown above.

SP_SET(?)

Description Sets the RS-232 settings for the Calibrator rear-panel RS-232 serial port, which is saved in the Calibrator non-volatile memory. (While saving configuration data in the non-volatile memory, a period of about 2 seconds, the Calibrator does not respond to remote commands.) The factory default values are shown below in **bold** type. (To return to the factory defaults, see the **FORMAT SETUP** command.)

The interface selection sets the command response, with command echo back for commands and error messages with **TERM** (terminal) or no echo back with **COMP** (computer)

Parameters <baud rate value>, 300, 600, 1200, 2400, 4800, **9600**, 19200, 38400, 57600, 115200
<interface>, **COMP** (computer), **TERM** (terminal)

<flow control>, **XON** (xon/xoff), NOSTALL, RTS (rts/cts)
 <number data bits>, DBIT7 (7 bits) or **DBIT8** (8 bits)
 <number stop bits>, **SBIT1** (1 bit) or SBIT2 (2 bits)
 <parity>, **PNONE** (none), PODD (odd), PEVEN (even)
 <end of line char.> CR (carriage return), LF (line feed),
 CRLF (carriage return/line feed)

Example SP_SET 9600,COMP,XON,DBIT8,SBIT1,PNONE,CRLF

Set the parameters for the rear-panel RS-232 serial port to the factory default values.

Query SP_SET? Returns the RS-232 setting for the Calibrator rear-panel RS-232 serial port.

Example SP_SET? Returns 9600,COMP,XON,DBIT8,SBIT1,PNONE,CRLF.

Returns the parameters for the rear-panel RS-232 serial port, as shown, when set to the factory default values.

SPLSTR(?) <text>

Description Sets the Serial Poll String (string up to 40 characters) which is saved in the Calibrator non-volatile memory. (While saving configuration data in the non-volatile memory, a period of about 2 seconds, the Calibrator does not respond to remote commands.) The SPLSTR is sent to the host over the serial interface when a ^P (<cntl> P) character is sent. The default format is:

SPL: %02x %02x %04x %04x

where the term %02x (8 bits) means print the value in hexadecimal with exactly 2 hex digits, and %04x (16 bits) means print the value in hexadecimal with exactly 4 hex digits. The string representations are:

SPL: (STB) (ESR) (ISCR0) (ISCR1)

See the commands, respectively, *STB?, *ESR?, ISCR0?, and ISCR1?. A typical string in the default format sent to the host is: SPL: 44 00 0000 1000. This command is for format. For values instead of format, enter a ^P (<cntl> p) character. Also see the SRQSTR command.

Parameters "<string>\n" (\n represents the NEWLINE character, hex 0A)

Example SPLSTR "SPL: %02x %02x %04x %04x\n"

Sets the Serial Poll String to the default values SPL: %02x %02x %04x %04x\n.

Query SPLSTR? Returns the string programmed for Serial Poll response.

***SRE(?) <value>**

Description Loads a byte into the Service Request Enable (SRE) register. (See "Service Request Enable Register (SRE)" in Chapter 5). Since bit 6 is not used (decimal value 64), the maximum entry is 255 - 64 = 191.

Parameters <value> The decimal equivalent of the SRE byte 0 to 191

Example *SRE 56 Enable bits 3 (EAV), 4 (MAV), and 5 (ESR).

Query SRE? Returns the decimal equivalent of the byte in the Service Request Enable (SRE).

SRQSTR(?) <text>

Description Sets the Serial Mode SRQ (Service Request) response (up to 40 characters) in the Calibrator non-volatile memory. (While saving configuration data in the non-volatile memory, a period of about 2 seconds, the Calibrator does not respond to remote commands.) The SRQSTR is sent to the host over the serial interface when the MSS bit is asserted (terminal mode only). Default format is:

SRQ: %02x %02x %04x %04x

where the term %02x (8 bits) means print the value in hexadecimal with exactly 2 hex digits, and %04x (16 bits) means print the value in hexadecimal with exactly 4 hex digits. The string representations are:

SRQ: (STB) (ESR) (ISCR0) (ISCR1)

See the commands, respectively, *STB?, *ESR?, ISCR0?, and ISCR1?. A typical string in the default format sent to the host is: SRQ: 44 00 0000 1000. This command is for format. See the SPLSTR command for the serial poll response.

Parameters "<string>\n" (\n represents the Line Feed character, hex 0A)

Example SRQSTR "SRQ: %02x %02x %04x %04x\n"

Sets the SRQSTR to the default values SRQ: %02x %02x %04x %04x\n.

Query SRQSTR? Returns the string programmed for Serial Mode SRQ response.

***STB?**

Description Returns the byte for the Status Byte Register. (See "Status Byte Register (STB)" in Chapter 5).

Response <value> The decimal equivalent of the STB byte, 0 to 255.

Example STB? Returns 72 if bits 3 (EAV) and 6 (MSS) are set.

STBY

Description Deactivates the Calibrator output if it is in operate. This is the same as pressing  on the Calibrator front panel.

Response None

Example STBY Disconnect the selected output from the Calibrator front-panel terminals.

SUBNETMASK(?) <string>

Description Sets the Ethernet static subnet mask. Stores the setting in non-volatile memory. The static subnet mask must be entered as a quoted string in the form of "XXX.XXX.XXX.XXX". A limited attempt to verify that the address is valid (i.e. in the correct format) is performed. The static subnet mask will be used if DHCP (Dynamic Host Configuration Protocol) is disabled and will be applied the next time the unit is power cycled. If DHCP is enabled, the subnet mask is automatically set by the DHCP server.

Parameters <string> Ethernet static subnet mask.

Example SUBNETMASK "255.255.254.0"

Query SUBNETMASK? Returns the Ethernet static subnet mask.

Chapter 7

Maintenance

Title	Page
Introduction.....	7-3
How to Replace the Line Fuse.....	7-3
How to Replace the Current Fuses.....	7-5
How to Clean the Air Filter	7-7
General Cleaning	7-8
Performance Tests.....	7-9

Introduction

This chapter explains how to perform the routine maintenance and calibration task required to keep a normally operating 5080A Calibrator in service. These tasks include:

- Replacing the fuse
- Cleaning the air filter
- Cleaning the external surfaces
- Calibration verification

Refer to the Service manual for intensive maintenance tasks such as troubleshooting, calibration or repair, and all procedures that require opening the cover of the instrument. The Service Manual also contains complete, detailed verification and calibration procedures.

How to Replace the Line Fuse

Caution



To prevent possible damage to the instrument, verify the correct fuse is installed for the selected line voltage setting 100 V and 120 V, use 5.0 A/250 V time delay (slow blow); 220 V and 240 V, use 2.5 A/250 V time delay (slow blow).

The line power fuse is accessible on the rear panel. The fuse rating is 5 A/250 V slow blow fuse for the 100 V/120 V line voltage setting; 2.5 A/250 V slow blow fuse for the 220 V/240 V line voltage setting.

To check or replace the fuse, refer to Figure 7-1 and proceed as follows:

1. **Disconnect line power.**
2. Open the fuse compartment by inserting a screwdriver blade in the tab located at the left side of the compartment and gently pry until it can be removed with the fingers.
3. Remove the fuse from the compartment for replacement or verification. Be sure the correct fuse is installed.
4. Reinstall the fuse compartment by pushing it back into place until the tab locks.

Table 7-1. Replacement Fuses

Line Voltage Setting	Fuse Description	Fluke Part Number
100 V or 120 V	5.0A, 250V, Slow Blow, 0.25 x 1.25 	109215
220 V or 240 V	2.5A, 250V, Slow Blow, 0.25 x 1.25 	851931

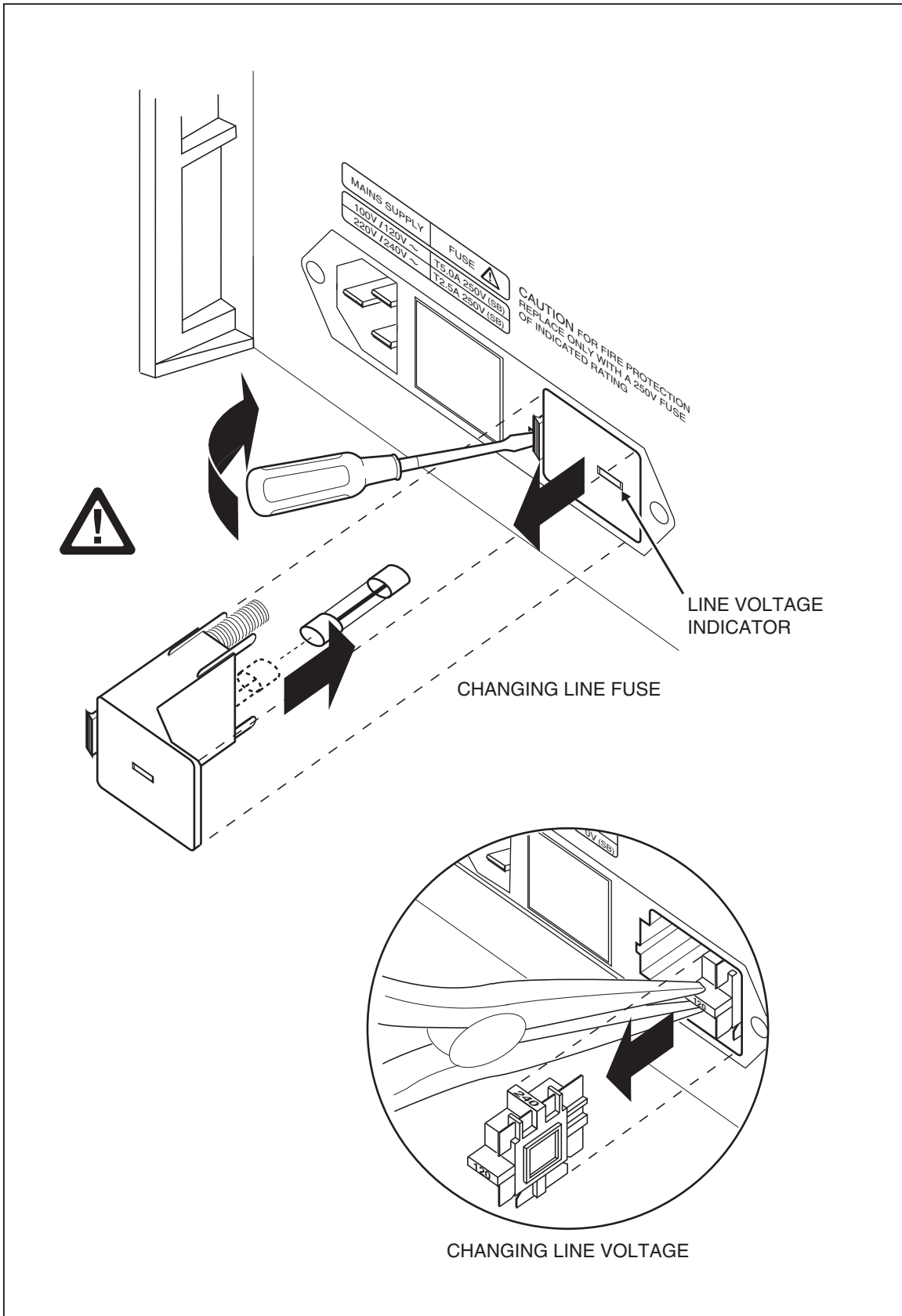

Figure 7-1. Accessing the Fuse

nn007f.eps

How to Replace the Current Fuses

The two Calibrator current outputs are protected by fuses. If the Calibrator is unable to source current, one or both of the current fuses may be blown.

Warning

To avoid electric shock, turn the Calibrator off, remove the power cord, and wait two minutes to allow the power assemblies to completely discharge before opening the current fuse access door.

To replace the current output fuses:

1. Turn off the Calibrator, remove the power cord, and wait two minutes for the power assemblies to fully discharge.
2. Turn the Calibrator over.
3. Remove the two screws that hold the fuse compartment cover in place and remove the cover as shown in Figure 7-2.

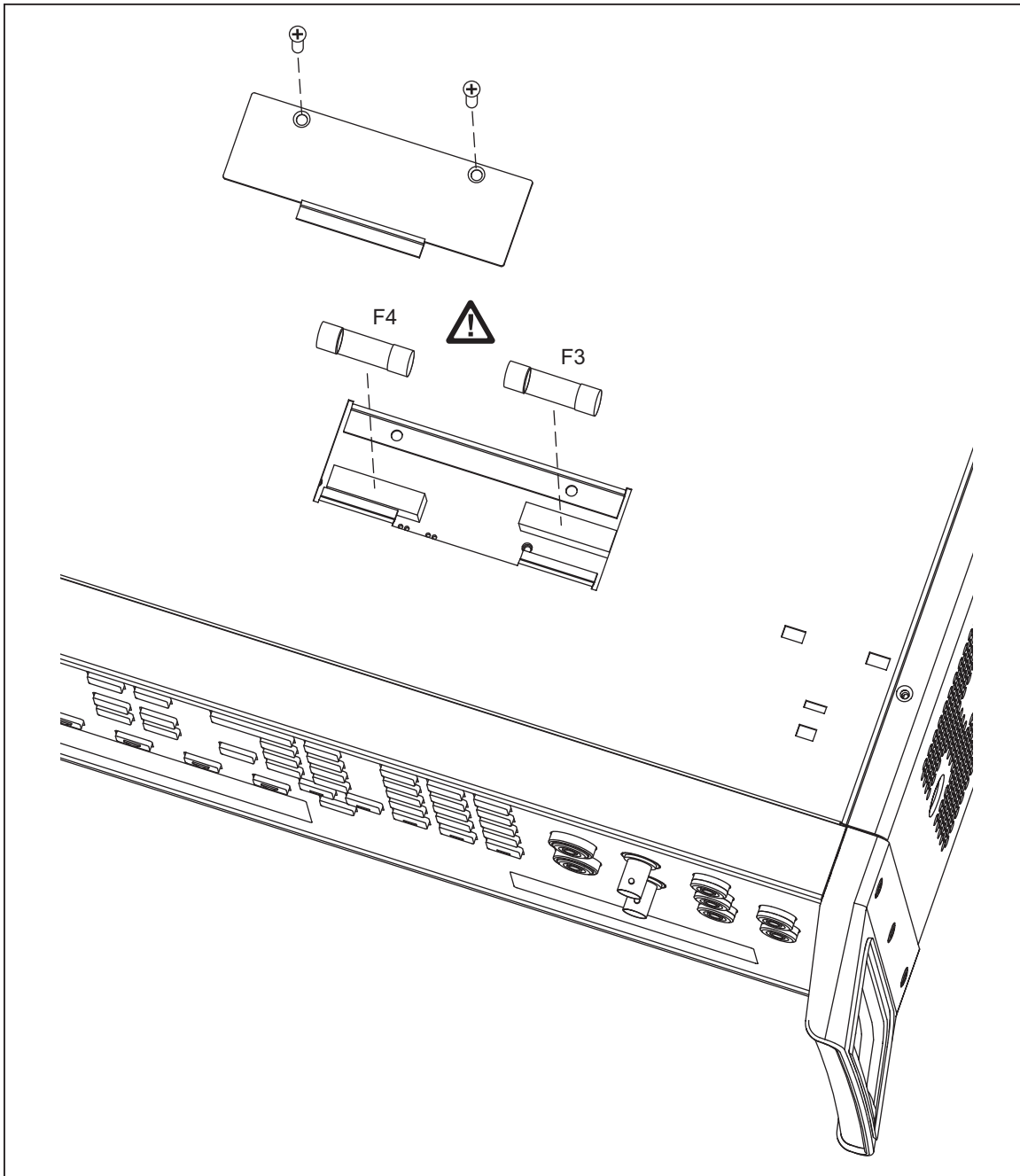

gew368.eps

Figure 7-2. Current Fuse Compartment

4. Remove and check the fuses as necessary. Table 7-2 lists the part number and rating of each fuse.

Table 7-2. Current Fuses

Current Output	Fuse Description	Fluke Part Number
AUX	4A/500V Ultra-Fast Blow (F3)	3674001
20A	25A/250V Fast Blow (F4)	3470596

5. Replace fuses as required.

6. Replace the fuse compartment door and secure the door with the screws removed in step 3.

How to Clean the Air Filter

⚠ Warning

To avoid risk of injury, never operate or power the 5080A calibrator without the fan filter in place.

⚠ Caution

Damage caused by overheating may occur if the area around the fan is restricted, the intake air is too warm, or the filter becomes clogged.

The air filter must be removed and cleaned every 30 days, or more frequently if the calibrator is operated in a dusty environment. The air filter is accessible from the rear panel of the calibrator.

To clean the air filter, refer to Figure 7-3 and proceed as follows:

1. Turn off the power, let the fan come to rest, and unplug the ac line cord.
2. Remove the filter element.
 - a. Grasp the top and bottom of the air filter frame.
 - b. Squeeze the edges of the frame towards each other to disengage the filter tabs from the slots in the Calibrator.
 - c. Pull the filter frame straight out from the Calibrator.
3. Clean the filter element,
 - a. Wash the filter element in soapy water.
 - b. Rinse the filter element thoroughly.
 - c. Shake out the excess water, then allow the filter element to dry thoroughly before reinstalling it.
4. Reinstall the filter element by performing the filter removal steps in reverse order.

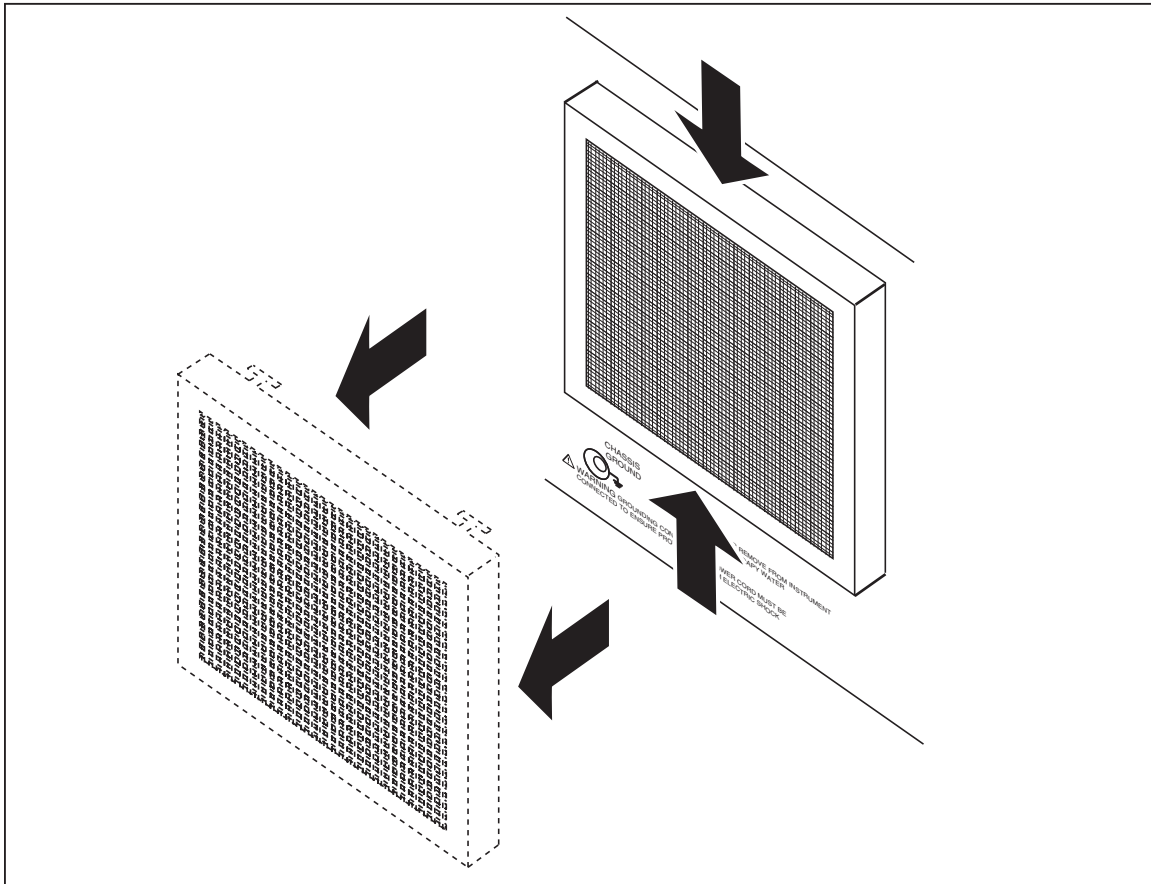

Figure 7-3. Accessing the Air Filter

oq062f.eps

General Cleaning

For general cleaning, wipe the case, front-panel keys, and lens using a soft cloth slightly dampened with water or a non-abrasive mild cleaning solution that does not harm plastics.

⚠ Caution

To avoid damaging the plastic materials used in the Calibrator, do not use aromatic hydrocarbons or chlorinated solvents for cleaning.

Performance Tests

To verify that the 5080A meets its specifications, you can use Tables 7-3 through 7-12. The tables are for qualified metrology personnel who have access to a standards laboratory that is properly equipped to test calibration equipment of this level of accuracy. The tables show the recommended test points and the acceptable upper and lower limits for each point. The limits were computed simply by adding or subtracting the 90-day specification from the output value. There is no built-in factor for measurement uncertainty. If you need more detailed verification and calibration adjustment instructions, order the *5080A Service Manual*.

Table 7-3. Verification Tests for DC Voltage (Normal)

Range	Output	Nominal	Lower Limit	Upper Limit
330 mV	0V .3V range	0	-0.00001 mV	0.00001 mV
330 mV	0.3V .3V range	0.3	0.299951 mV	0.300049 mV
330 mV	-0.3V .3V range	-0.3	-0.300049 mV	-0.299951 mV
3.3 V	0V 3V range	0	-0.000015 V	0.000015 V
3.3 V	0.3V 3V range	0.3	0.299955 V	0.300045 V
3.3 V	-0.3V 3V range	-0.3	-0.300045 V	-0.299955 V
3.3 V	1V 3V range	1	0.999885 V	1.000115 V
3.3 V	-1V 3V range	-1	-1.000115 V	-0.999885 V
3.3 V	3V 3V range	3	2.999685 V	3.000315 V
3.3 V	-3V 3V range	-3	-3.000315 V	-2.999685 V
33 V	0V 30V range	0	-0.00015 V	0.00015 V
33 V	30V 30V range	30	29.99685 V	30.00315 V
33 V	-30V 30V range	-30	-30.00315 V	-29.99685 V
330 V	30V 300V range	30	29.9949 V	30.0051 V
330 V	-30V 300V range	-30	-30.0051 V	-29.9949 V
330 V	300V 300V range	300	299.9625 V	300.0375 V
330 V	-300V 300V range	-300	-300.0375 V	-299.9625 V
1000 V	100V 1000V range	100	99.9825 V	100.0175 V
1000 V	-100V 1000V range	-100	-100.0175 V	-99.9825 V
1000 V	1000V 1000V range	1000	999.8745 V	1000.1255 V
1000 V	-1000V 1000V range	-1000	-1000.1255 V	-999.8745 V

Table 7-4. Verification Tests for DC Voltage (AUX)

Range	Output	Nominal	Lower Limit	Upper Limit
330 mV	0V .3V range	0	-0.001 mV	0.001 mV
330 mV	0.3V .3V range	0.3	0.29864 mV	0.30136 mV
330 mV	-0.3V .3V range	-0.3	-0.30136 mV	-0.29864 mV
3.3 V	0.33V 3V range	0.33	0.328604 V	0.331396 V
3.3 V	-0.33V 3V range	-0.33	-0.331396 V	-0.328604 V
3.3 V	3V 3V range	3	2.9954 V	3.0046 V
3.3 V	-3V 3V range	-3	-3.0046 V	-2.9954 V
7 V	3.3V 7V range	3.3	3.29504 V	3.30496 V
7 V	-3.3V 7V range	-3.3	-3.30496 V	-3.29504 V
7 V	7V 7V range	7	6.9906 V	7.0094 V
7 V	-7V 7V range	-7	-7.0094 V	-6.9906 V

Table 7-5. Verification Tests for DC Current

Range	Output	Nominal	Lower Limit	Upper Limit
330 μ A	0.000 μ A	0 μ A	-0.0000001 μ A	0.0000001 μ A
330 μ A	300.000 μ A	0.0003 μ A	0.000299675 μ A	0.000300325 μ A
330 μ A	-300.000 μ A	-0.0003 μ A	-0.000300325 μ A	-0.000299675 μ A
3.3 mA	0.00000 mA	0 mA	-0.00000025 mA	0.00000025 mA
3.3 mA	3.00000 mA	0.003 mA	0.0029978 mA	0.0030022 mA
3.3 mA	-3.00000 mA	-0.003 mA	-0.0030022 mA	-0.0029978 mA
33 mA	0.00000 mA	0 mA	-0.00000125 mA	0.00000125 mA
33 mA	30.0000 mA	0.03 mA	0.02998375 mA	0.03001625 mA
33 mA	-30.0000 mA	-0.03 mA	-0.03001625 mA	-0.02998375 mA
330 mA	0.0000 mA	0 mA	-0.0000165 mA	0.0000165 mA
330 mA	300.000 mA	0.3 mA	0.2998335 mA	0.3001665 mA
330 mA	-300.000 mA	-0.3 mA	-0.3001665 mA	-0.2998335 mA
1 A	0.0000000 A	0 A	-0.00022 A	0.00022 A
1 A	1.00000 A	1 A	0.99828 A	1.00172 A
1 A	-1.00000 A	-1 A	-1.00172 A	-0.99828 A
3 A	0.0000000 A	0 A	-0.00022 A	0.00022 A
3 A	2.90000 A	2.9 A	2.89427 A	2.90573 A
3 A	-2.90000 A	-2.9 A	-2.90573 A	-2.89427 A
11 A	0.0000000 A	0A	-0.0025 A	0.0025 A

Table 7-5. Verification Tests for DC Current (cont.)

Range	Output	Nominal	Lower Limit	Upper Limit
11 A	10.0000 A	10 A	9.9725 A	10.0275 A
11 A	-10.0000 A	-10 A	-10.0275 A	-9.9725 A
20 A	0.0000000 A	0 A	-0.00375 A	0.00375 A
20 A	20.0000 A	20 A	19.89625 A	20.10375 A
20 A	-20.0000 A	-20 A	-20.10375 A	-19.89625 A

Table 7-6. Verification Tests for 2-Wire Resistance

Range	Output	Nominal	Lower Limit	Upper Limit
1 Ω	0.00000 Ω	0 Ω	-0.011 Ω	0.011 Ω
1 Ω	1.00000 Ω	1 Ω	0.998 Ω	1.002 Ω
1.9 Ω	1.90000 Ω	1.9 Ω	1.8895 Ω	1.9105 Ω
10 Ω	10.0000 Ω	10 Ω	9.984 Ω	10.016 Ω
19 Ω	19.0000 Ω	19 Ω	18.98 Ω	19.02 Ω
100 Ω	100.0000 Ω	100 Ω	99.959 Ω	100.041 Ω
190 Ω	190.000 Ω	190 Ω	189.923 Ω	190.077 Ω
1 kΩ	1.000000 kΩ	1000 Ω	999.74 Ω	1000.26 Ω
1.9 kΩ	1.90000 kΩ	1900 Ω	1899.515 Ω	1900.485 Ω
10 kΩ	10.00000 kΩ	10000 Ω	9997.4 Ω	10002.6 Ω
19 kΩ	19.0000 kΩ	19000 Ω	18994.29 Ω	19005.71 Ω
100 kΩ	100.0000 kΩ	100000 Ω	99960 Ω	100040 Ω
190 kΩ	190.00 kΩ	190000 Ω	189912.2 Ω	190087.8 Ω
1 MΩ	1.000000 MΩ	1000000 Ω	999600 Ω	1000400 Ω
1.9 MΩ	1.90000 MΩ	1900000 Ω	1899240 Ω	1900760 Ω
10 MΩ	10.0000 MΩ	10000000 Ω	9990000 Ω	10010000 Ω
19 MΩ	19.000 MΩ	19000000 Ω	18971500 Ω	19028500 Ω
100 MΩ	100.000 MΩ	100000000 Ω	99500000 Ω	100500000 Ω
190 MΩ	190.0 MΩ	190000000 Ω	188100000 Ω	191900000 Ω

Table 7-7. Verification Tests for 4-Wire Resistance

Range	Output	Nominal	Lower Limit	Upper Limit
1 Ω	0.00000 Ω	0 Ω	-0.01 Ω	0.01 Ω
1 Ω	1.00000 Ω	1 Ω	0.999 Ω	1.001 Ω
1.9 Ω	1.90000 Ω	1.9 Ω	1.8905 Ω	1.9095 Ω
10 Ω	10.0000 Ω	10 Ω	9.985 Ω	10.015 Ω

Table 7-7. Verification Tests for 4-Wire Resistance (cont.)

Range	Output	Nominal	Lower Limit	Upper Limit
19 Ω	19.0000 Ω	19 Ω	18.981 Ω	19.019 Ω
100 Ω	100.0000 Ω	100 Ω	99.96 Ω	100.04 Ω
190 Ω	190.000 Ω	190 Ω	189.924 Ω	190.076 Ω
1 k Ω	1.000000 k Ω	1000 Ω	999.75 Ω	1000.25 Ω
1.9 k Ω	1.90000 k Ω	1900 Ω	1899.525 Ω	1900.475 Ω
10 k Ω	10.00000 k Ω	10000 Ω	9997.5 Ω	10002.5 Ω
19 k Ω	19.0000 k Ω	19000 Ω	18994.49 Ω	19005.51 Ω
100 k Ω	100.0000 k Ω	100000 Ω	99962 Ω	100038 Ω
190 k Ω	190.00 k Ω	190000 Ω	189920.2 Ω	190079.8 Ω

Table 7-8. Verification Tests for AC Voltage (Normal)

Range	Output	Nominal	Lower Limit	Upper Limit
33 mV	30.000 mV @ 45 Hz	0.03 mV	0.029841 mV	0.030159 mV
33 mV	30.000 mV @ 65 Hz	0.03 mV	0.029841 mV	0.030159 mV
33 mV	30.000 mV @ 500 Hz	0.03 mV	0.029838 mV	0.030162 mV
33 mV	30.000 mV @ 1 kHz	0.03 V	0.029838 V	0.030162 V
330 mV	0.10000 V @ 45 Hz	0.1 V	0.09979 V	0.10021 V
330 mV	0.100000 V @ 65 Hz	0.1 V	0.09979 V	0.10021 V
330 mV	0.100000 V @ 500 Hz	0.1 V	0.09978 V	0.10022 V
330 mV	0.100000 V @ 1 kHz	0.1 V	0.09978 V	0.10022 V
330 mV	300.000 mV @ 45 Hz	0.3 V	0.29949 V	0.30051 V
330 mV	300.000 mV @ 65 Hz	0.3 V	0.29949 V	0.30051V
330 mV	300.000 mV @ 500 Hz	0.3 V	0.29946 V	0.30054 V
330 mV	300.000 mV @ 1 kHz	0.3 V	0.29946 V	0.30054 V
3.3 V	1.0000 V @ 45 Hz	1 V	0.99882 V	1.00118 V
3.3 V	1.00000 V @ 65 Hz	1 V	0.99882 V	1.00118 V
3.3 V	1.00000 V @ 500 Hz	1 V	0.99872 V	1.00128 V
3.3 V	1.00000 V @ 1 kHz	1 V	0.99872 V	1.00128 V
3.3 V	3.00000 V @ 100 Hz	3 V	2.99652 V	3.00348 V

Table 7-8. Verification Tests for AC Voltage (Normal) (cont.)

Range	Output	Nominal	Lower Limit	Upper Limit
3.3 V	3.00000 V @ 200 Hz	3 V	2.99652 V	3.00348 V
3.3 V	3.00000 V @ 500 Hz	3 V	2.99652 V	3.00348 V
3.3 V	3.00000 V @ 1 kHz	3 V	2.99652 V	3.00348 V
33 V	10.0000 V @ 45 Hz	10 V	9.9882 V	10.0118 V
33 V	10.00000 V @ 65 Hz	10 V	9.9882 V	10.0118 V
33 V	10.00000 V @ 500 Hz	10 V	9.9862 V	10.0138 V
33 V	10.00000 V @ 1 kHz	10 V	9.9862 V	10.0138 V
33 V	30.0000 V @ 45 Hz	30 V	29.9682 V	30.0318 V
33 V	30.00000 V @ 65 Hz	30 V	29.9682 V	30.0318 V
33 V	30.00000 V @ 500 Hz	30 V	29.9622 V	30.0378 V
33 V	30.00000 V @ 1 kHz	30 V	29.9622 V	30.0378 V
330 V	100.0000 V @ 45 Hz	100 V	99.842 V	100.158 V
330 V	100.00000 V @ 65 Hz	100 V	99.842 V	100.158 V
330 V	100.00000 V @ 500 Hz	100 V	99.832 V	100.168 V
330 V	100.00000 V @ 1 kHz	100 V	99.832 V	100.168 V
330 V	300.0000 V @ 45 Hz	300 V	299.562 V	300.438 V
330 V	300.00000 V @ 65 Hz	300 V	299.562 V	300.438 V
330 V	300.00000 V @ 500 Hz	300 V	299.532 V	300.468 V
330 V	300.00000 V @ 1 kHz	300 V	299.532 V	300.468 V
1000 V	1000.00 V @ 45 Hz	1000 V	998.42 V	1001.58 V
1000 V	1000.00 V @ 65 Hz	1000 V	998.42 V	1001.58 V
1000 V	1000.00 V @ 500 Hz	1000 V	998.32 V	1001.68 V
1000 V	1000.00 V @ 1 kHz	1000 V	998.32 V	1001.68 V

Table 7-9. Verification Tests for AC Current

Range	Output	Nominal	Lower Limit	Upper Limit
330 μ A	300.00 μ A @ 45 Hz	0.0003	0.0002985	0.0003015
330 μ A	300.00 μ A @ 65 Hz	0.0003	0.0002985	0.0003015
330 μ A	300.00 μ A @ 500 Hz	0.0003	0.00029847	0.00030153
330 μ A	300.00 μ A @ 1 kHz	0.0003	0.00029847	0.00030153
3.3 mA	3.0000 mA @ 45 Hz	0.003	0.0029925	0.0030075
3.3 mA	3.0000 mA @ 65 Hz	0.003	0.0029925	0.0030075
3.3 mA	3.0000 mA @ 500 Hz	0.003	0.0029922	0.0030078

Table 7-9. Verification Tests for AC Current (cont.)

Range	Output	Nominal	Lower Limit	Upper Limit
3.3 mA	3.0000 mA @ 1 kHz	0.003	0.0029922	0.0030078
33 mA	10.000 mA @ 45 Hz	0.01	0.009978	0.010022
33 mA	10.000 mA @ 65 Hz	0.01	0.009978	0.010022
33 mA	30.000 mA @ 45 Hz	0.03	0.029958	0.030042
33 mA	30.000 mA @ 65 Hz	0.03	0.029958	0.030042
33 mA	30.000 mA @ 500 Hz	0.03	0.029931	0.030069
33 mA	30.000 mA @ 1 kHz	0.03	0.029931	0.030069
330 mA	100.000 mA @ 45 Hz	0.1	0.09978	0.10022
330 mA	100.000 mA @ 65 Hz	0.1	0.09978	0.10022
330 mA	300.000 mA @ 45 Hz	0.3	0.29958	0.30042
330 mA	300.000 mA @ 65 Hz	0.3	0.29958	0.30042
330 mA	300.000 mA @ 500 Hz	0.3	0.29931	0.30069
330 mA	300.000 mA @ 1 kHz	0.3	0.29931	0.30069
1 A	1.00000 A @ 45 Hz	1	0.9978	1.0022
1 A	1.00000 A @ 65 Hz	1	0.9978	1.0022
1 A	1.0000 A @ 1 kHz	1	0.9969	1.0031
3 A	2.9000 A @ 45 Hz	2.9	2.8956	2.9044
3 A	2.9000 A @ 65 Hz	2.9	2.8956	2.9044
3 A	2.9000 A @ 1 kHz	2.9	2.89038	2.90962
11 A	10.000 A @ 45 Hz	10	9.969	10.031
11 A	10.000 A @ 65 Hz	10	9.969	10.031
11 A	10.000 A @ 1 kHz	10	9.954	10.046
20 A	20.000 A @ 45 Hz	20	19.889	20.111
20 A	20.000 A @ 65 Hz	20	19.889	20.111
20 A	20.000 A @ 1 kHz	20	19.895	20.105

Table 7-10. Verification Tests for Phase

Range	Output	Nominal	Lower Limit	Upper Limit
3 V	0.00 ° @ 60 Hz	0 °	-0.25 °	0.25 °
3 V	0.00 ° @ 400 Hz	0 °	-1.5 °	1.5 °
3 V	60.00 ° @ 60 Hz	60 °	59.75 °	60.25 °
3 V	60.00 ° @ 400 Hz	60 °	58.5 °	61.5 °
3 V	90.00 ° @ 60 Hz	90 °	89.75 °	90.25 °
3 V	90.00 ° @ 400 Hz	90 °	88.5 °	91.5 °

Table 7-11. Verification Tests for Distortion

Range	Output	Nominal	Lower Limit	Upper Limit
3 V	0.000 % @ 45 Hz	0 %	0 %	0.1002 %
3 V	0.000 % @ 100 Hz	0 %	0 %	0.1002 %
30 V	0.000 % @ 45 Hz	0 %	0 %	0.50002 %
30 V	0.000 % @ 1 kHz	0 %	0 %	0.50002 %
100 V	0.000 % @ 100 Hz	0 %	0 %	0.50003 %
100 V	0.000 % @ 1 kHz	0 %	0 %	0.50003 %

Table 7-12. Verification Tests for Frequency

Range	Output	Nominal	Lower Limit	Upper Limit
3 V	100.00000 Hz @ 3 V	100	99.993 Hz	100.007 Hz

Appendix A

Glossary

adc (analog-to-digital converter)

A device or circuit that converts an analog signal to a digital signal.

absolute uncertainty

Uncertainty specifications that include the error contributions made by all equipment and standards used to calibrate the instrument. Absolute uncertainty is the number to compare with the UUT for determining test uncertainty ratio.

accuracy

The degree to which the measured value of a quantity agrees with the true (correct) value of that quantity. For example, an instrument specified to ± 1 % uncertainty is 99 % accurate.

apparent power

The power value obtained by simply multiplying the ac current by the ac voltage on a circuit without consideration of any phase relationship between the two waveforms. (See “true power” for comparison.)

assert

To cause a digital signal to go into a logic true state.

af (audio frequency)

The frequency range of human hearing; normally 15 - 20,000 Hz.

base units

Units in the SI system that are dimensionally independent. All other units are derived from base units. The only base unit in electricity is the ampere.

buffer

1. An area of digital memory for temporary storage of data.
2. An amplifier stage before the final amplifier.

burden voltage

The maximum sustainable voltage across the terminals of a load.

compliance voltage

The maximum voltage a constant-current source can supply.

control chart

A chart devised to monitor one or more processes to detect the excessive deviation from a desired value of a component or process.

crest factor

The ratio of the peak voltage to the rms voltage of a waveform (with the dc component removed).

dac (digital-to-analog converter)

A device or circuit that converts a digital waveform to an analog voltage.

dBm

A reference power level of 1 mW expressed in decibels.

derived units

Units in the SI system that are derived from base units. Volts, ohms, and watts are derived from amperes and other base and derived units.

displacement power factor

Refers to the displacement component of power factor; the ratio of the active power of the fundamental wave, in watts, to the apparent power of the fundamental wave, in volt-amperes.

distortion

Undesired changes in the waveform of a signal. Harmonic distortion disturbs the original relationship between a frequency and other frequencies naturally related to it. Intermodulation distortion (imd) introduces new frequencies by the mixing of two or more original frequencies. Other forms of distortion are phase distortion and transient distortion.

errors

The different types of errors described in this glossary are “offset error,” “linearity error,” “random error,” “scale error,” “systematic errors,” and “transfer error.”

flatness

A measure of the variation of the actual output of an ac voltage source at different frequency points when set to the same nominal output level. A flat voltage source exhibits very little error throughout its frequency range.

floor

The part of the uncertainty specification of an instrument that is typically a fixed offset plus noise. Floor can be expressed as units, such as microvolts, or counts of the least significant digit. For the 5080A, the floor specification is combined with fixed range errors in one term to determine total uncertainty.

full scale

The maximum reading of a range of a meter, analog-to-digital converter, or other measurement device, or the maximum attainable output on a range of a calibrator.

gain error

Same as scale error. Scale or gain error results when the slope of the meter’s response curve is not exactly 1. A meter with only gain error (no offset or linearity error), will read 0 V with 0 V applied, but something other than 10 V with 10 V applied.

ground

The voltage reference point in a circuit. Earth ground is a connection through a ground rod or other conductor to the earth, usually accessible through the ground conductor in an ac power receptacle.

ground loops

Undesirable currents induced when there is more than one chassis ground potential in a system of instruments. Ground loops can be minimized by connecting all instruments in a system to ground at a common point.

guard

See “voltage guard” and “current guard.”

harmonics

A waveform that is an integral multiple of the fundamental frequency. For example, a waveform that is twice the frequency of the fundamental is called the second harmonic.

International Systems of Units

Same as “SI System of Units,” the accepted system of units. See also “units,” “base units,” and “derived units.”

legal units

The highest echelon in a system of units, for example the U.S. National Institute of Standards volt.

life-cycle cost

The consideration of all elements contributing to the cost of an instrument throughout its useful life. This includes initial purchase cost, service and maintenance cost, and the cost of support equipment.

linearity

The relationship between two quantities when a change in the first quantity is directly proportional to a change in the second quantity.

linearity error

Linearity error occurs when the response curve of a meter is not exactly a straight line. This type of error is measured by fixing two points on the response curve, drawing a line through the points, then measuring how far the curve deviates from the straight line at various points in the response curve.

MAP (Measurement Assurance Program)

A program for measurement process. A MAP provides information to demonstrate that the total uncertainty of the measurements (data), including both random error and systematic components of error relative to national or other designated standards, is quantified, and sufficiently small to meet requirements.

MTBF (Mean Time Between Failures)

The time interval in operating hours that can be expected between failure of equipment. MTBF can be calculated from direct observation or mathematically derived through extrapolation.

MTTF (Mean Time To Fail)

The time interval in operating hours that can be expected until the first failure of equipment. MTTF can be calculated from direct observation or mathematically derived through extrapolation.

MTTR (Mean Time to Repair)

The average time in hours required to repair failed equipment.

metrology

The science of, and the field of knowledge concerned with, measurement.

minimum use specifications

A compilation of specifications that satisfies the calibration requirements of a measurement system or device. The minimum use specifications are usually determined by maintaining a specified test uncertainty ratio between the calibration equipment and the unit under test.

noise

A signal containing no useful information that is superimposed on a desired or expected signal.

normal mode noise

An undesired signal that appears between the terminals of a device.

offset error

Same as zero error. The reading shown on a meter when an input value of zero is applied is its offset or zero error.

parameters

Independent variables in a measurement process such as temperature, humidity, test lead resistance, etc.

power factor

The ratio of actual power used in a circuit, expressed in watts, to the power which is apparently being drawn from the source, expressed in volt-amperes.

precision

The precision of a measurement process is the coherence, or the closeness to the one result, of all measurement results. High precision, for example would result in a tight pattern of arrow hits on a target, without respect to where on the target the tight pattern falls.

predictability

A measure of how accurately the output value of a device can be assumed after a known time following calibration. If a device is highly stable, it is also predictable. If a device is not highly stable, but its value changes at the same rate every time after calibration, its output has a higher degree of predictability than a device that exhibits random change.

primary standard

A standard defined and maintained by some authority and used to calibrate all other secondary standards.

process metrology

Tracking the accuracy drift of calibration and other equipment by applying statistical analysis to correction factors obtained during calibration.

random error

Any error which varies in an unpredictable manner in absolute value and in sign when measurements of the same value of a quantity are made under effectively identical conditions.

range

The stated upper end of a measurement device's span. Usually, however, a measurement device can measure quantities for a specified percentage overrange. (The absolute span including overrange capability is called "scale.") In the 5080A, however, range and scale are identical.

reference standard

The highest-echelon standard in a laboratory; the standard that is used to maintain working standards that are used in routine calibration and comparison procedures.

relative uncertainty

5080A uncertainty specifications that exclude the effects of external dividers and standards, for use when range constants are adjusted. Relative uncertainty includes only the stability, temperature coefficient, noise, and linearity specifications of the 5080A itself.

reliability

A measure of the “uptime” of an instrument.

repeatability

The degree of agreement among independent measurements of a quantity under the same conditions.

resistance

A property of a conductor that determines the amount of current that will flow when a given amount of voltage exists across the conductor. Resistance is measured in ohms. One ohm is the resistance through which one volt of potential will cause one ampere of current to flow.

resolution

The smallest change in quantity that can be detected by a measurement system or device. For a given parameter, resolution is the smallest increment that can be measured, generated, or displayed.

rf (radio frequency)

The frequency range of radio waves; from 150 kHz up to the infrared range.

rms (root-mean-square)

The value assigned to an ac voltage or current that results in the same power dissipation in a resistance as a dc current or voltage of the same value.

rms sensor

A device that converts ac voltage to dc voltage with great accuracy. RMS sensors operate by measuring the heat generated by a voltage through a known resistance (i.e., power); therefore, they sense true rms voltage.

scale

The absolute span of the reading range of a measurement device including overrange capability.

scale error

Same as gain error. Scale or gain error results when the slope of the meter’s response curve is not exactly 1. A meter with only scale error (no offset or linearity error), will read 0 V with 0 V applied, but something other than 10 V with 10 V applied.

secondary standard

A standard maintained by comparison against a primary standard.

sensitivity

The degree of response of a measuring device to the change in input quantity, or a figure of merit that expresses the ability of a measurement system or device to respond to an input quantity.

shield

A grounded covering device designed to protect a circuit or cable from electromagnetic interference.

SI System of Units

The accepted International System of Units. See also “units,” “base units,” and “derived units.”

specifications

A precise statement of the set of requirements satisfied by a measurement system or device.

stability

A measure of the freedom from drift in value over time and over changes in other variables such as temperature. Note that stability is not the same as uncertainty.

standard

A device that is used as an exact value for reference and comparison.

systematic errors

Errors in repeated measurement results that remain constant or vary in a predictable way.

temperature coefficient

A factor per °C deviation from a nominal value or range that the uncertainty of an instrument increases. This specification is necessary to account for the thermal coefficients in a calibrator’s analog circuitry.

test uncertainty ratio

The numerical ratio of the uncertainty of the measurement system or device being calibrated to the uncertainty of the measurement system or device used as the calibrator. (Also called “test accuracy ratio.”)

thermal emf

The voltage generated when two dissimilar metals joined together are heated.

traceability

The ability to relate individual measurement results to national standards or nationally accepted measurement systems through an unbroken chain of comparisons, i.e., a calibration “audit trail.”

Measurements, measurement systems, and devices have traceability to designated standards if and only if scientifically rigorous evidence is produced on a continuing basis to show that the measurement process is producing measurement results for which the total measurement uncertainty relative to national or other designated standards is qualified.

transfer error

The sum of all new errors induced during the process of comparing one quantity against another.

transfer standard

Any working standard used to compare a measurement process, system, or device at one location or level with another measurement process, system, or device at another location or level.

transport standard

A transfer standard that is rugged enough to allow shipment by common carrier to another location.

true power

The actual power (real power) used to produce heat or work. Compare to “apparent power.”

true value

The accepted, consensus, i.e., correct, value of the quantity being measured. Also called “legal value.”

uncertainty

The maximum difference between the accepted, consensus, or true value and the measured value of a quantity. Uncertainty is normally expressed in units of ppm (parts per million) or as a percentage.

units

Symbols or names that define the measured quantities. Examples of units are: V, mV, A, kW, and dBm. See also “SI System of Units.”

UUT (Unit Under Test)

An abbreviated name for an instrument that is being tested or calibrated.

var

Symbol for volt-ampere reactive, the unit of reactive power, as opposed to real power in watts.

verification

Checking the functional performance and uncertainty of an instrument or standard without making adjustments to it or changing its calibration constants.

volt

The unit of emf (electromotive force) or electrical potential in the SI system of units. One volt is the difference of electrical potential between two points on a conductor carrying one ampere of current, when the power being dissipated between these two points is equal to one watt.

voltage guard

A floating shield around voltage measurement circuitry inside an instrument. The voltage guard provides a low-impedance path to ground for common-mode noise and ground currents, thereby eliminating errors introduced by such interference.

watt

The unit of power in the SI system of units. One watt is the power required to do work at the rate of one joule/second. In terms of volts and ohms, one watt is the power dissipated by one ampere flowing through a one-ohm load.

working standard

A standard that is used in routine calibration and comparison procedures in the laboratory, and is maintained by comparison to reference standards.

zero error

Same as offset error. The reading shown on a meter when an input value of zero is applied is its zero or offset error.

Appendix B

RS-232 Cabling and Connector

Serial Connector

A 9-pin serial connector on the rear panel of the 5080A Calibrator is used to interface with a computer or controller. The pin assignments of the rear-panel serial connector conforms to EIA/TIA-574 standard and is shown in Figure B-1.

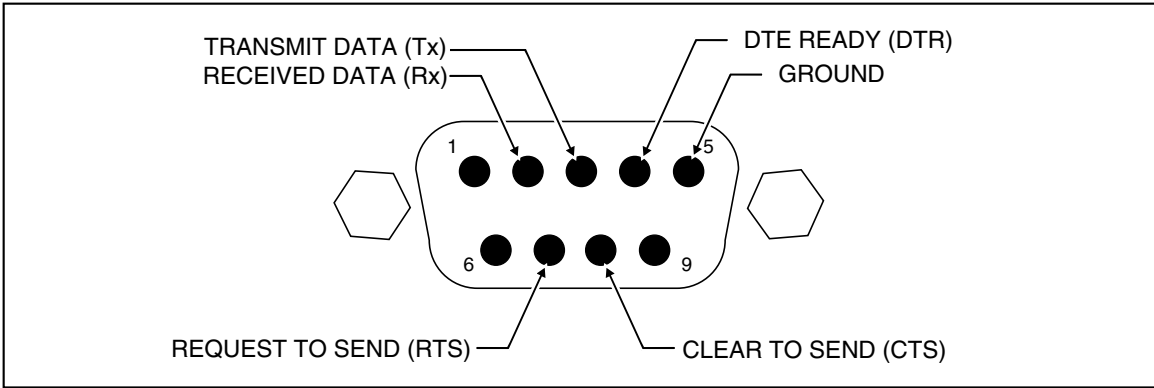

Figure B-1. Serial Port Connector Pinout

fe-02.eps

Appendix C

Error Messages

Error Messages

The following is a list of the 5080A Calibrator error messages. The error message format is shown in Table C-1.

Table C-1. Error Messages and Format

Error Number	(Message Class : Description)		Text Characters
0 to 65535	QYE Query Error, caused by a full input buffer, unterminated action or interrupted action	F Error is displayed on the front panel as it occurs	Up to 36 text characters
	DDE Device-Specific Error, caused by the 5080A due to some condition, for example, overrange	R Error is queued to the remote interface as it occurs	
	EXE Execution Error, caused by an element outside of, or inconsistent with, the 5080A capabilities	S Error causes instrument to go to Standby	
	CME Command Error, caused by incorrect command syntax, unrecognized header, or parameter of the wrong type	D Error causes instrument returns to the power up state	
		(none) Error is returned to the initiator only (i.e., local initiator or remote initiator)	

0	(QYE:)	No Error
1	(DDE:FR)	Error queue overflow
100	(DDE:FR D)	Inguard not responding (send)
102	(DDE:FR D)	Lost sync with inguard
104	(DDE:FR D)	Hardware relay trip occurred

105	(DDE:FR D)	Inguard got impatient
108	(DDE:FR)	Inguard is obsolete
109	(DDE:FR D)	Inguard parity error
110	(DDE:FR D)	Inguard overrun error
111	(DDE:FR D)	Inguard framing error
112	(DDE:FR D)	Inguard fault error
113	(DDE:FR D)	Inguard fault input error
114	(DDE:FR D)	Inguard fault detect error
116	(DDE:FR D)	Received unexpected data (IG)
200	(DDE:FR D)	Can't download waveform
300	(DDE:)	Invalid procedure number
301	(DDE:)	No such step in procedure
302	(DDE:)	Can't change that while busy
303	(DDE:)	Can't begin/resume cal there
304	(DDE:)	Wrong unit for reference
305	(DDE:)	Entered value out of bounds
306	(DDE:)	Not waiting for a reference
307	(DDE:)	Continue command ignored
308	(DDE:FR)	Cal constant outside limits
309	(DDE:FR)	Cal try to null failed
310	(DDE:FR D)	Sequence failed during cal
311	(DDE:FR D)	A/D measurement failed
312	(DDE:FR)	Invalid cal step parameter
313	(DDE:)	Cal switch must be ENABLED
314	(DDE:FR)	Divide by zero encountered
315	(DDE: FR)	Must be in OPER at this step
317	(DDE:FR)	Bad reference Z or entry
318	(DDE:FR)	Cal takes DAC over top limit
319	(DDE: R)	Zero cal needed every 7 days
330	(DDE: R)	File name not found
340	(DDE: R)	Directory not found
398	(QYE:F)	Unusual cal fault %d
399	(QYE:F)	Unusual during %s
400	(DDE:FR D)	Encoder not responding VERS
403	(DDE:FR)	Encoder self-test failed
405	(DDE:FR)	Message over display R side
406	(DDE:FR)	Unmappable character #%d
407	(DDE:FR)	Encoder did not reset
408	(DDE:FR)	Encoder got invalid command
409	(DDE:FR D)	Encoder unexpectedly reset
501	(DDE:)	Invalid keyword or choice
503	(DDE:)	Frequency must be ≥ 0
504	(DDE:)	AC magnitude must be > 0
505	(DDE:)	Impedance must be ≥ 0
506	(DDE:)	Function not available
507	(DDE:)	Value not available
508	(DDE:)	Cannot enter watts by itself
509	(DDE:)	Output exceeds user limits
511	(DDE:)	Power factor must be 0.0-1.0
512	(DDE:)	Can't select that field now
513	(DDE:)	Edit digit out of range
515	(DDE:)	Not editing output now

516	(DDE:)	dBm only for single sine ACV
517	(DDE:)	Freq too high for non-sine
518	(DDE:)	Value outside locked range
519	(DDE:)	Must specify an output unit
520	(DDE:)	Can't do two freqs at once
521	(DDE:)	Can't source 3 values at once
523	(DDE:)	Can't do that now
526	(DDE:)	Limit too small or large
527	(DDE:)	No changes except RESET now
528	(DDE:)	Offset out of range
529	(DDE:)	Cannot edit to or from 0 Hz
530	(DDE:)	Bad state image - not loaded
533	(DDE:)	Can't set an offset now
534	(DDE:)	Can't lock this range
535	(DDE:)	Can't set phase or PF now
536	(DDE:)	Can't set wave now
539	(DDE:)	Can't change compensation now
542	(DDE:)	Can't turn EARTH on now
543	(DDE: R)	STA couldn't update OTD
544	(DDE:)	Can't enter W with non-sine
546	(DDE:)	Can't set trigger to that now
547	(DDE:)	Can't set output imp. now
548	(DDE:FR)	Compensation is now OFF
549	(DDE:)	Period must be ≥ 0
550	(DDE:)	A report is already printing
554	(DDE:)	MegOhm Option not installed
555	(DDE:)	Not a MegOhm function
558	(DDE:)	Not a range for this function
573	(DDE:)	No trig unless OPER & settled
580	(DDE:FR)	(STA) begin not called
590	(DDE:)	Can't get DHCP IP address
591	(DDE:)	Can't set sensing now
700	(DDE: R)	NV memory invalid
701	(DDE: FR)	NV invalid so default loaded
702	DDE: FR)	Can't load config setup
703	(DDE: R)	Can't write config setup
704	(DDE:FR)	Can't access cal directory
705	(DDE:FR)	Can't load old cal constants
707	(DDE:FR)	Can't load cal constants
708	(DDE:FR)	Can't write cal constants
709	(DDE:FR)	Can't load ENET/IP data
710	(DDE:FR)	Can't write ENET/IP data
711	(DDE:FR)	Can't load ENET/MAC data
712	(DDE:FR)	Can't write ENET/MAC data
800	(DDE:FR)	RS-232 format error detected
810	(DDE:FR)	Error opening serial port
811	(DDE:FR)	Error configuring serial port
821	(DDE:FR)	Port value out of range
822	(DDE:FR)	could not open the ENET port
824	(DDE:FR)	Error reading from ENET port
825	(DDE:FR)	Ethernet address not valid
826	(DDE:FR)	Ethernet hostname not valid

827	(DDE:FR)	Ethernet hostname too long
1000	(DDE:FR)	Sequence failed during diag
1300	(CME: R)	Bad syntax
1301	(CME: R)	Unknown command
1302	(CME: R)	Bad parameter count
1303	(CME: R)	Bad keyword
1304	(CME: R)	Bad parameter type
1305	(CME: R)	Bad parameter unit
1306	(EXE: R)	Bad parameter value
1307	(QYE: R)	488.2 I/O deadlock
1308	(QYE: R)	488.2 interrupted query
1309	(QYE: R)	488.2 unterminated command
1310	(QYE: R)	488.2 query after indefinite response
1312	(DDE: R)	Invalid from serial interface
1313	(DDE: R)	Service only
1314	(EXE: R)	Parameter too long
1315	(CME: R)	Invalid device trigger
1317	(CME: R)	Serial buffer full
1319	(EXE: R)	Service command failed
1320	(CME: R)	Bad binary number
1321	(CME: R)	Bad binary block
1323	(CME: R)	Bad decimal number
1324	(CME: R)	Exponent magnitude too large
1326	(CME: R)	Bad hexadecimal number
1328	(CME: R)	Bad octal number
1329	(CME: R)	Too many characters
1330	(CME: R)	Bad string
1331	(DDE: R)	OPER not allowed while error pending
1500	(DDE:FRS)	Compliance voltage exceeded
1502	(DDE:FRS)	Thermal Limit Exceeded
1503	(DDE:FRS)	Output current limit exceeded
1504	(DDE:FRS)	Compliance voltage limit exceeded
1505	(DDE:FRS)	VDAC counts out of range
1506	(DDE:FRS)	IDAC out of range
1507	(DDE:FRS)	AC scale dac counts out of range
1508	(DDE:FRS)	DC scale dac counts out of range
1509	(DDE:FRS)	Frequency dac counts out of range
1510	(DDE:FRS)	IDAC counts (DC OFFSET) out of range
1511	(DDE:FRS)	Input V or A limit exceeded
1517	(DDE:FRS)	Unknown range
1600	(FR)	Failed to mount USB drive
1601	(FR)	Failed to copy files
1602	(FR)	Can't modify file property
1603	(FR)	Update execution error %d
65526	(DDE:FR)	Unknown error %d